

TQSDT



AIR CONDITIONER

Owner's Manual

Original Instructions

Split Air Conditioner



Thank you for choosing our product.
Please read this Owner's Manual carefully before operation and retain it for future reference.

If you have lost the Owner's Manual, please contact the local agent or visit www.gree.com or send an email to global@gree.com.cn for the electronic version.

MTS2R-18HDI

MTS4R-28HDI

In line with the company's policy of continual product improvement, the aesthetic and dimensional characteristics, technical data and accessories of this appliance may be changed without notice.

CONTENTS

GENERAL INFORMATION

GENERAL INFORMATION	Conformity And Range	1
	The Refrigerant	2
	Warning	3
	The Instructions Before Use	6
	Name of Parts	7
	Technical Data	9
	Outdoor Unit Working Temperature Range	9
INSTALLER	Electrical Connections	10
	Installing The Outdoor Unit	14
	Bleeding	14
	Maintenance	15
	Installation Dimension Diagram	15
	Check After Installation	16
	Safety Operation Of Flammable Refrigerant	17

The products in this manual may be different with the real one, according to different models, some models have displayer and some models without displayer, the position and shape of the displayer please refer to the real one.

This appliance is not intended for use by persons (including children) with reduced physical, sensory or mental capabilities, or lack of experience and knowledge, unless they have been given supervision or instruction concerning use of the appliance by a person responsible for their safety.

Children should be supervised to ensure that they do not play with the appliance.



This marking indicates that this product should not be disposed with other household wastes throughout the EU. To prevent possible harm to the environment or human health from uncontrolled waste disposal, recycle it responsibly to promote the sustainable reuse of material resources. To return your used device, please use the return and collection systems or contact the retailer where the product was purchased. They can take this product for environmental safe recycling.

R32: 675



Indicates a hazardous situation that, if not avoided, will result in death or serious injury.



Indicates a hazardous situation that, if not avoided, could result in death or serious injury.



Indicates a hazardous situation that, if not avoided, may result in minor or moderate injury.



Indicates important but not hazard-related information, used to indicate risk of property damage.



Indicates a hazard that would be assigned a signal word WARNING or CAUTION.



Please read this owner's manual carefully before operating the unit and keep it carefully for consultation.



Only use the air conditioner as instructed in this booklet. These instructions are not intended to cover every possible condition and situation. As with any electrical household appliance, common sense and caution are therefore always recommended for installation, operation and maintenance.

Please read this operating manual carefully before operating the unit.



Appliance filled with flammable gas R32.



Before use the appliance, read the owner's manual first.



Before install the appliance, read the installation manual first.



Before repair the appliance, read the service manual first.

The figures in this manual may be different with the material objects, please refer to the material objects for reference.

● The Refrigerant

- To realize the function of the air conditioner unit, a special refrigerant circulates in the system. The used refrigerant is the fluoride R32, which is specially cleaned. The refrigerant is flammable and inodorous. Furthermore, it can leads to explosion under certain conditions. But the flammability of the refrigerant is very low. It can be ignited only by fire.
- Compared to common refrigerants, R32 is a nonpolluting refrigerant with no harm to the ozonosphere. The influence upon the greenhouse effect is also lower. R32 has got very good thermodynamic features which lead to a really high energy efficiency. The units therefore need a less filling.

WARNING:

Do not use means to accelerate the defrosting process or to clean, other than those recommended by the manufacture. Should repair be necessary, contact your nearest authorized Service Centre.

Any repairs carried out by unqualified personnel may be dangerous.

The appliance shall be stored in a room without continuously operating ignition sources. (for example: open flames , an operating gas appliance or an operating electric heater.)

Do not pierce or burn.

Appliance shall be installed, operated and stored in a room with a floor area larger than $x \text{ m}^2$. (Please refer to table "a" in section of " Safety Operation of Inflammable Refrigerant" for Space X.)

Appliance filled with flammable gas R32. For repairs, strictly follow manufacturer's instructions only.

Be aware that refrigerants not contain odour.
Read specialist's manual.

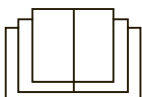



Operation and Maintenance

- This appliance can be used by children aged from 8 years and above and persons with reduced physical, sensory or mental capabilities or lack of experience and knowledge if they have been given supervision or instruction concerning use of the appliance in a safe way and understand the hazards involved.
- Children shall not play with the appliance.
- Cleaning and user maintenance shall not be made by children without supervision.
- Do not connect air conditioner to multi-purpose socket. Otherwise, it may cause fire hazard.
- Do not disconnect power supply when cleaning air conditioner. Otherwise, it may cause electric shock.
- If the supply cord is damaged, it must be replaced by the manufacturer, its service agent or similarly qualified persons in order to avoid a hazard.
- Do not wash the air conditioner with water to avoid electric shock.
- Do not spray water on indoor unit. It may cause electric shock or malfunction.
- After removing the filter, do not touch fins to avoid injury.
- Do not use fire or hair dryer to dry the filter to avoid deformation or fire hazard.
- Maintenance must be performed by qualified professionals. Otherwise, it may cause personal injury or damage.
- Do not repair air conditioner by yourself. It may cause electric shock or damage. Please contact dealer when you need to repair air conditioner.
- Do not extend fingers or objects into air inlet or air outlet. It may cause personal injury or damage.
- Do not block air outlet or air inlet. It may cause malfunction.
- Do not spill water on the remote controller, otherwise the remote controller may be broken.
- When below phenomenon occurs, please turn off air conditioner and disconnect power immediately, and then contact the dealer or qualified professionals for service.
 - Power cord is overheating or damaged.
 - There's abnormal sound during operation.
 - Circuit break trips off frequently.
 - Air conditioner gives off burning smell.
 - Indoor unit is leaking.



- If the air conditioner operates under abnormal conditions, it may cause malfunction, electric shock or fire hazard.
- When turning on or turning off the unit by emergency operation switch, please press this switch with an insulating object other than metal.
- Do not step on top panel of outdoor unit, or put heavy objects. It may cause damage or personal injury.

Attachment

- Installation must be performed by qualified professionals. Otherwise, it may cause personal injury or damage.
- Must follow the electric safety regulations when installing the unit.
- According to the local safety regulations, use qualified power supply circuit and circuit break.
- Do install the circuit break. If not, it may cause malfunction.
- An all-pole disconnection switch having a contact separation of at least 3mm in all poles should be connected in fixed wiring.
- Including an circuit break with suitable capacity, please note the following table. Air switch should be included magnet buckle and heating buckle function, it can protect the circuit-short and overload.
- Air Conditioner should be properly grounded. Incorrect grounding may cause electric shock.
- Don't use unqualified power cord.
- Make sure the power supply matches with the requirement of air conditioner. Unstable power supply or incorrect wiring or malfunction. Please install proper power supply cables before using the air conditioner.
- Properly connect the live wire, neutral wire and grounding wire of power socket.
- Be sure to cut off the power supply before proceeding any work related to electricity and safety.
- Do not put through the power before finishing installation.
- If the supply cord is damaged, it must be replaced by the manufacturer, its service agent or similarly qualified persons in order to avoid a hazard.
- The temperature of refrigerant circuit will be high, please keep the interconnection cable away from the copper tube.
- The appliance shall be installed in accordance with national wiring regulations.
- Installation must be performed in accordance with the requirement of NEC and CEC by authorized personnel only.



- The air conditioner is the first class electric appliance. It must be properly grounding with specialized grounding device by a professional. Please make sure it is always grounded effectively, otherwise it may cause electric shock.
- The yellow-green wire in air conditioner is grounding wire, which can't be used for other purposes.
- The grounding resistance should comply with national electric safety regulations.
- The appliance must be positioned so that the plug is accessible.
- All wires of indoor unit and outdoor unit should be connected by a professional.
- If the length of power connection wire is insufficient, please contact the supplier for a new one. Avoid extending the wire by yourself.
- For the air conditioner with plug, the plug should be reachable after finishing installation.
- For the air conditioner without plug, an circuit break must be installed in the line.
- If you need to relocate the air conditioner to another place, only the qualified person can perform the work. Otherwise, it may cause personal injury or damage.
- Select a location which is out of reach for children and far away from animals or plants. If it is unavoidable, please add the fence for safety purpose.
- The indoor unit should be installed close to the wall.

WARNING

★ When having a burning smell or smoke, please turn off the power supply and contact with the service center.

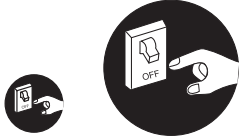

If the abnormality still exists, the unit may be damaged, and may cause electric shock or fire.

★ The power supply must adopt the special circuit that with air switch protection and assure it has enough capacity. The unit will be turned on or off according to your requirement automatically, please do not turn on or turn off the unit frequently, otherwise disadvantage effect may be caused to the unit.

★ Never cut off or damage power cables and control wires. If the power cable and signal control wire were damaged, change them by professional.



★ Power must adopt the special circuit to prevent fire.

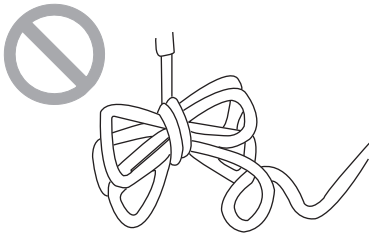

Otherwise, it can cause electric shock or fire.

★ Disconnect the power supply if long putting the air conditioner out of use.



Otherwise, the accumulated dusts may cause overheating or fire.

★ Never damage the electric wire or use the electric wire which is not appointed.



Otherwise, it will cause overheating or fire.

★ When cleaning, it is necessary to stop driving and turn off the power supply.

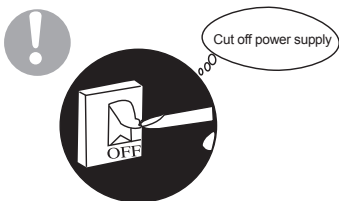

Otherwise, it may cause electric shock or damage.

★ Rated voltage of this air conditioner 220-240V, 50Hz, The compressor will vibrate sharply if the voltage is too low, resappointed. Damage to refrigerating system. Electrical component are easy to damage if the voltage is too high.

★ Don't attempt to repair the air conditioner by yourself.

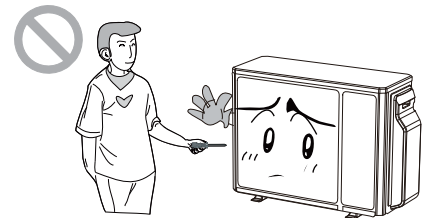

The wrong repair will lead to an electric shock or fire, so you should contact the service center to repair.

★ Please note whether the installed stand is firm enough or not.

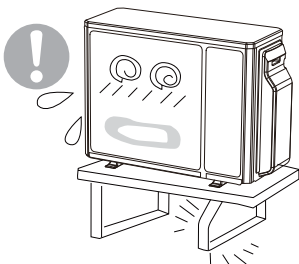

If it is damaged, it may lead to the fall of the unit and cause the injury.

★ Don't step on the top of the outdoor unit or place something on it.

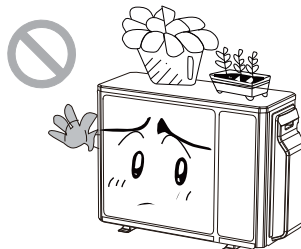

As falling off the outdoor unit can be dangerous.

★ Earthing: The unit must be reliably earthed. The earthing cable shall be connected to the special earthing device in the construction.



MTS2R-18HDI、 21K:

Warning

- Be sure to cut off the power supply before cleaning the air conditioner; otherwise electric shock might happen.
- Wetting of air conditioner may cause the risk of electric shock. Make sure not to wash your air conditioner in any case.
- Volatile liquids such as thinner or gasoline will cause damage to the appearance of air conditioner. (Only use soft dry cloth moist cloth clean the air conditioner cabinet).
- This product must not be disposed together with the domestic waste.
This product has to be disposed at an authorized place for recycling of electrical and electronic appliances.
- The temperature of refrigerant circuit will be high, please keep the interconnection cable away from the copper tube.



OUTDOOR UNIT	
No.	Description
1	Air outlet grille
2	Valve

Note: The above figures are only intended to a simple diagram of the appliance and may not correspond to the appearance of the units that have been purchased.

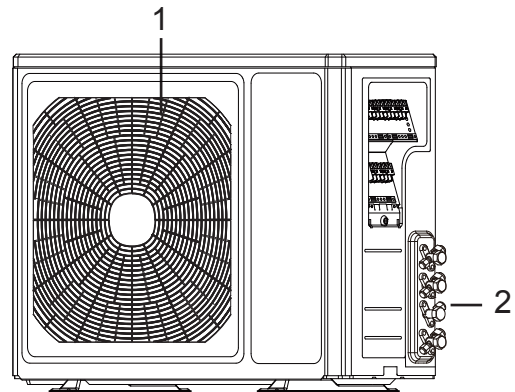

24K、 MTS4R-28HDI、 36K、 42K:

Warning

- If the supply cord is damaged, it must be replaced by the manufacturer or its service agent or a similarly qualified person in order to avoid a hazard.
- Be sure to cut off the power supply before cleaning the air conditioner; otherwise electric shock might happen.
- Wetting of air conditioner may cause the risk of electric shock. Make sure not to wash your air conditioner in any case.
- Volatile liquids such as thinner or gasoline will cause damage to the appearance of air conditioner. (Only use soft dry cloth moist cloth clean the air conditioner cabinet).
- Do not dispose this product as unsorted municipal waste. Collection of such waste separately for special treatment is necessary.
- The temperature of refrigerant circuit will be high, please keep the interconnection cable away from the copper tube.

OUTDOOR UNIT	
No.	Description
1	Air outlet grille
2	Valve

Note: The above figures are only intended to be a simple diagram of the appliance and may not correspond to the appearance of the units that have been purchased.

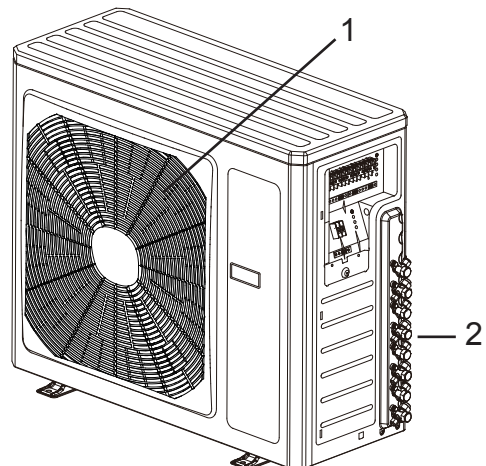

14K :

Warning

- Be sure to cut off the power supply before cleaning the air conditioner; otherwise electric shock might happen.
- Wetting of air conditioner may cause the risk of electric shock. Make sure not to wash your air conditioner in any case.
- Volatile liquids such as thinner or gasoline will cause damage to the appearance of air conditioner. (Only use soft dry cloth moist cloth clean the air conditioner cabinet).
- This product must not be disposed together with the domestic waste.
This product has to be disposed at an authorized place for recycling of electrical and electronic appliances.
- The temperature of refrigerant circuit will be high, please keep the interconnection cable away from the copper tube.



OUTDOOR UNIT	
No.	Description
1	Air outlet grille
2	Valve

Note: The above figures are only intended to a simple diagram of the appliance and may not correspond to the appearance of the units that have been purchased.

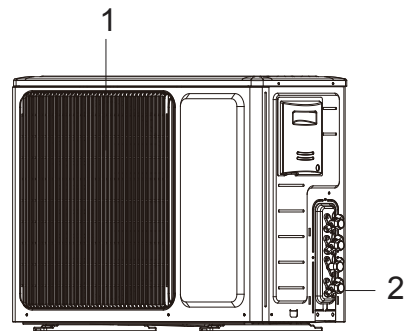

TECHNICAL DATA
GENERAL INFORMATION

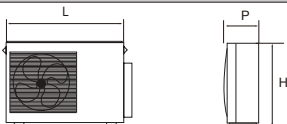
MODE	14K	MTS2R-18HDI	21K	
Electrical data				
Electricity supply	220-240V~,50Hz	220-240V~,50Hz	220-240V~,50Hz	
Fuse or air switch	10	16	25	
Minimum power cord section	1.0	1.5	2.5	mm ²
Size and clearance				
	L	899	955	mm
	P	378	396	mm
	H	596	700	mm

TECHNICAL DATA
GENERAL INFORMATION

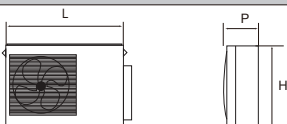
MODE	24K、MTS4R-28HDI			
Electrical data				
Electricity supply	220-240V~,50Hz			
Fuse or air switch	25			
Minimum power cord section	2.5			mm ²
Size and clearance				
	L	980		mm
	P	427		mm
	H	790		mm

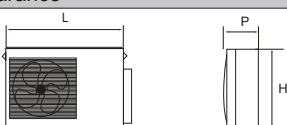
MODE	36K、42K			
Electrical data				
Electricity supply	220-240V~,50Hz			
Fuse or air switch	25			
Minimum power cord section	2.5			mm ²
Size and clearance				
	L	1087		mm
	P	440		mm
	H	1103		mm

OUTDOOR UNIT WORKING TEMPERATURE RANGE
GENERAL INFORMATION

For some models:

	Indoor side DB/WB(°C)	Outdoor side DB/WB(°C)
Maximum cooling	32/23	43/26
Maximum heating	27/-	24/18

- The operating temperature range (outdoor temperature) for cooling only unit is -15°C ~43°C ; for heat pump unit is -15°C ~ 43°C .

For some models:

	Indoor side DB/WB(°C)	Outdoor side DB/WB(°C)
Maximum cooling	32/23	43/26
Maximum heating	27/-	24/18

- The operating temperature range (outdoor temperature) for cooling only unit is -15°C ~43°C ; for heat pump unit is -20°C ~ 43°C .

For some models:

	Indoor side DB/WB(°C)	Outdoor side DB/WB(°C)
Maximum cooling	32/23	43/26
Maximum heating	27/-	24/18

- The operating temperature range (outdoor temperature) for cooling only unit is 18°C ~43°C .

14K:

1. Remove the handle at the right side plate of the outdoor unit (one screw).
2. Remove the cable clamp, connect the power connection cable with the terminal at the row of connection and fix the connection. The fitting line distributing must be consistent with the indoor unit. terminal of line bank. Wiring should meet that of indoor unit.
3. Fix power connection wire by wire clamp.
4. Ensure wire has been fixed well.
5. Install the handle.

! Including an air switch with suitable capacity, please note the following table. Air switch should be included magnet buckle and heating buckle function, it can protect the circuit-short and overload. (Caution: please do not use the fuse only for protect the circuit)

Air-conditioner	Air switch capacity
14K	10A

- !** An all-pole disconnection switch having a contact separation of at least 3mm in all pole should be connected in fixed wiring.
- !** Wrong wire connection may cause malfunction of some electric components. After fixing cable, ensure that leads between connection to fixed point have some space.
- !** The connection pipes and the connecting wirings of the unit A, unit B must be corresponding to each other respective.
- !** The appliance shall be installed in accordance with national wiring regulations.

Note: The above figures are only intended to be a simple diagram of the appliance and may not correspond to the appearance of the units that have been purchased.

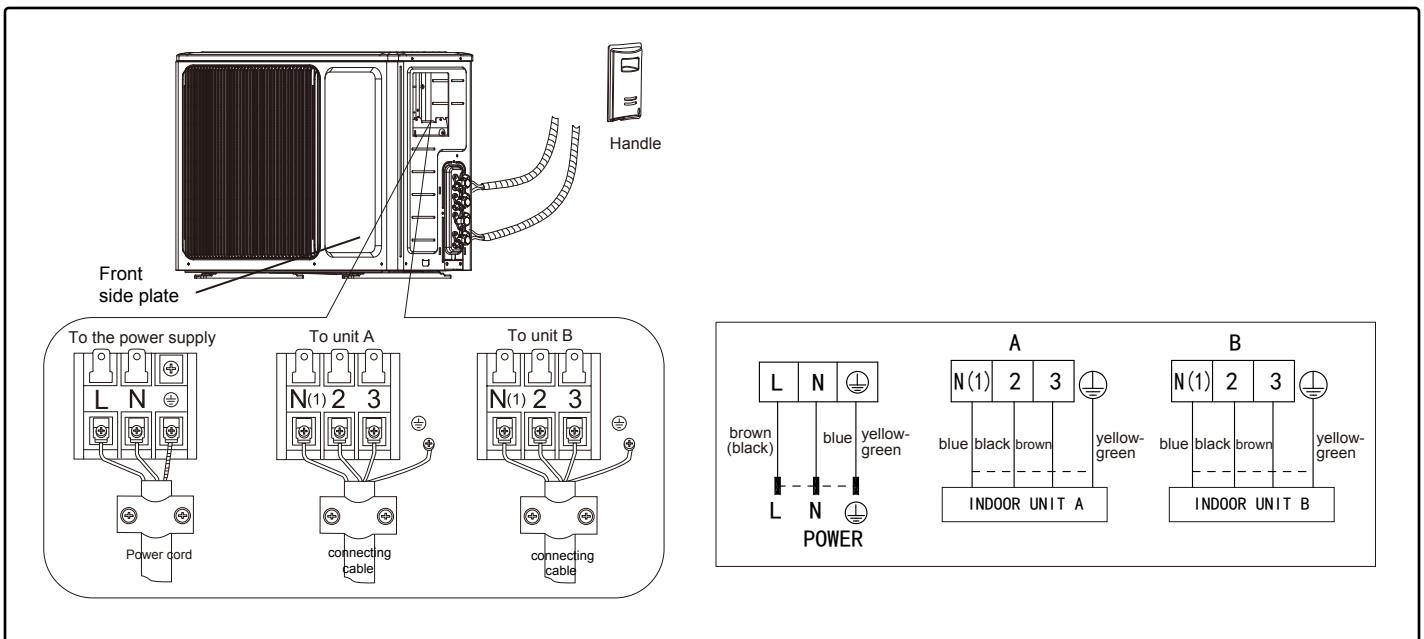

HANDLING

USER

- !** After having removed the packaging, check that the contents are intact and complete.
- !** The outdoor unit must always be kept upright.

! Handling must be done by suitably equipped qualified technical personnel using equipment that is for suitable the weight of the appliance.

MTS2R-18HDI、21K、24K

1. Remove the handle at the right side plate of the outdoor unit (one screw).
2. Remove the cable clamp, connect the power connection cable with the terminal at the row of connection and fix the connection. The fitting line distributing must be consistent with the indoor unit. terminal of line bank. Wiring should meet that of indoor unit.
3. Fix power connection wire by wire clamp.
4. Ensure wire has been fixed well.
5. Install the handle.

! Including an air switch with suitable capacity, please note the following table. Air switch should be included magnet buckle and heating buckle function, it can protect the circuit-short and overload. (Caution: please do not use the fuse only for protect the circuit)

Air-conditioner	Air switch capacity
MTS2R-18HDI	16A
21K	25A
24K	25A

! An all-pole disconnection switch having a contact separation of at least 3mm in all pole should be connected in fixed wiring.

! Wrong wire connection may cause malfunction of some electric components. After fixing cable, ensure that leads between connection to fixed point have some space.

! The connection pipes and the connecting wirings of the unit A and unit B, unit C must be corresponding to each other respective.

! The appliance shall be installed in accordance with national wiring regulations.

Note: the above figures are only intended to be a simple diagram of the appliance and may not correspond to the appearance of the units that have been purchased.

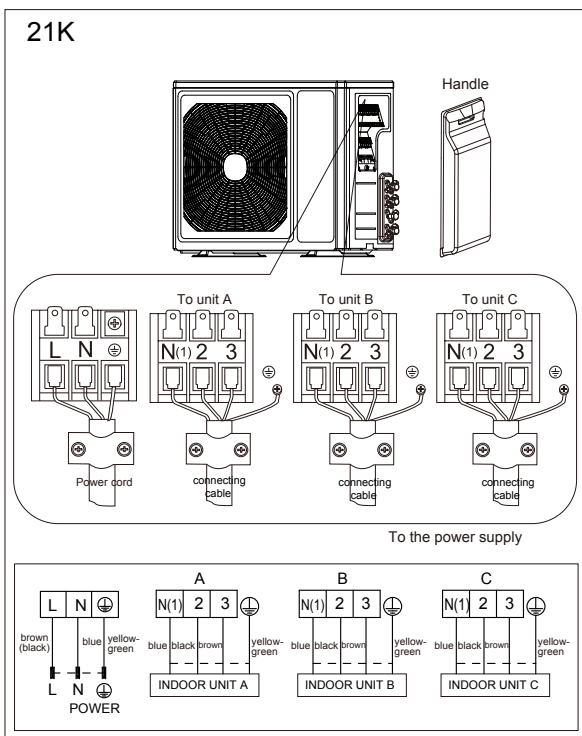

MTS2R-18HDI

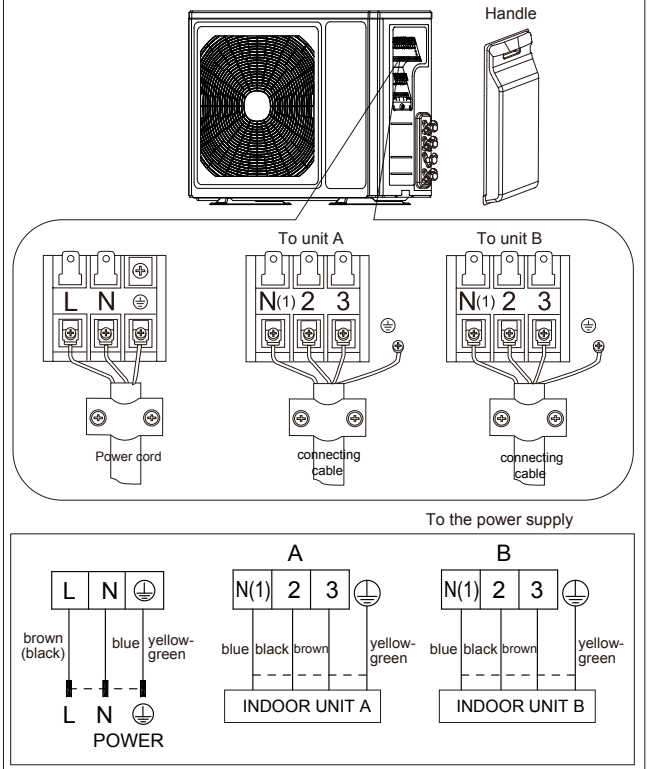

24K

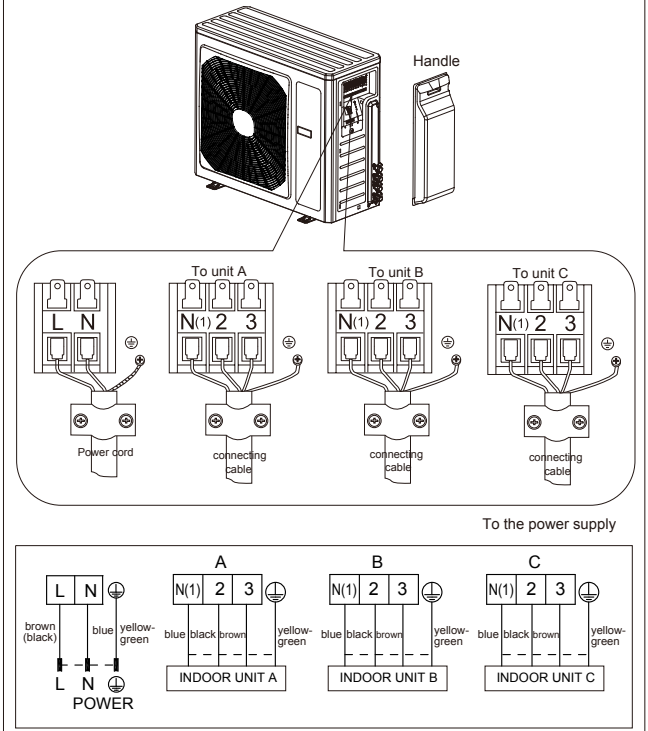

To be in compliance with EN/IEC 61000-3-11, impedance value of power-supply system connected to product must be less than or equal to the allowable maximum value of $|Z_{sys}|$ in the following sheet:

models	max $ Z_{sys} $ unit:ohms
21K	0.199

Before connecting the product to public power network, please consult your local power supply authority to ensure that the power network has met the above requirements. no requirement for the unlisted product's impedance value of power-supply system.

MTS4R-28HDI、 36K :

1. Remove the handle at the right side plate of the outdoor unit (one screw).
2. Remove the cable clamp, connect the power connection cable with the terminal at the row of connection and fix the connection. The fitting line distributing must be consistent with the indoor unit. terminal of line bank. Wiring should meet that of indoor unit.
3. Fix power connection wire by wire clamp.
4. Ensure wire has been fixed well.
5. Install the handle.



An all-pole disconnection switch having a contact separation of at least 3mm in all pole should be connected in fixed wiring.



Wrong wire connection may cause malfunction of some electric components. After fixing cable, ensure that leads between connection to fixed point have some space.



The connection pipes and the connecting wirings of the unit A, unit B, unit C and unit D must be corresponding to each other respective.



The appliance shall be installed in accordance with national wiring regulations.



Including an air switch with suitable capacity, please note the following table. Air switch should be included magnet buckle and heating buckle function, it can protect the circuit-short and overload. (Caution: please do not use the fuse only for protect the circuit)

Note: The above figures are only intended to be a simple diagram of the appliance and may not correspond to the appearance of the units that have been purchased.

Air-conditioner	Air switch capacity
MTS4R-28HDI 36K	25A

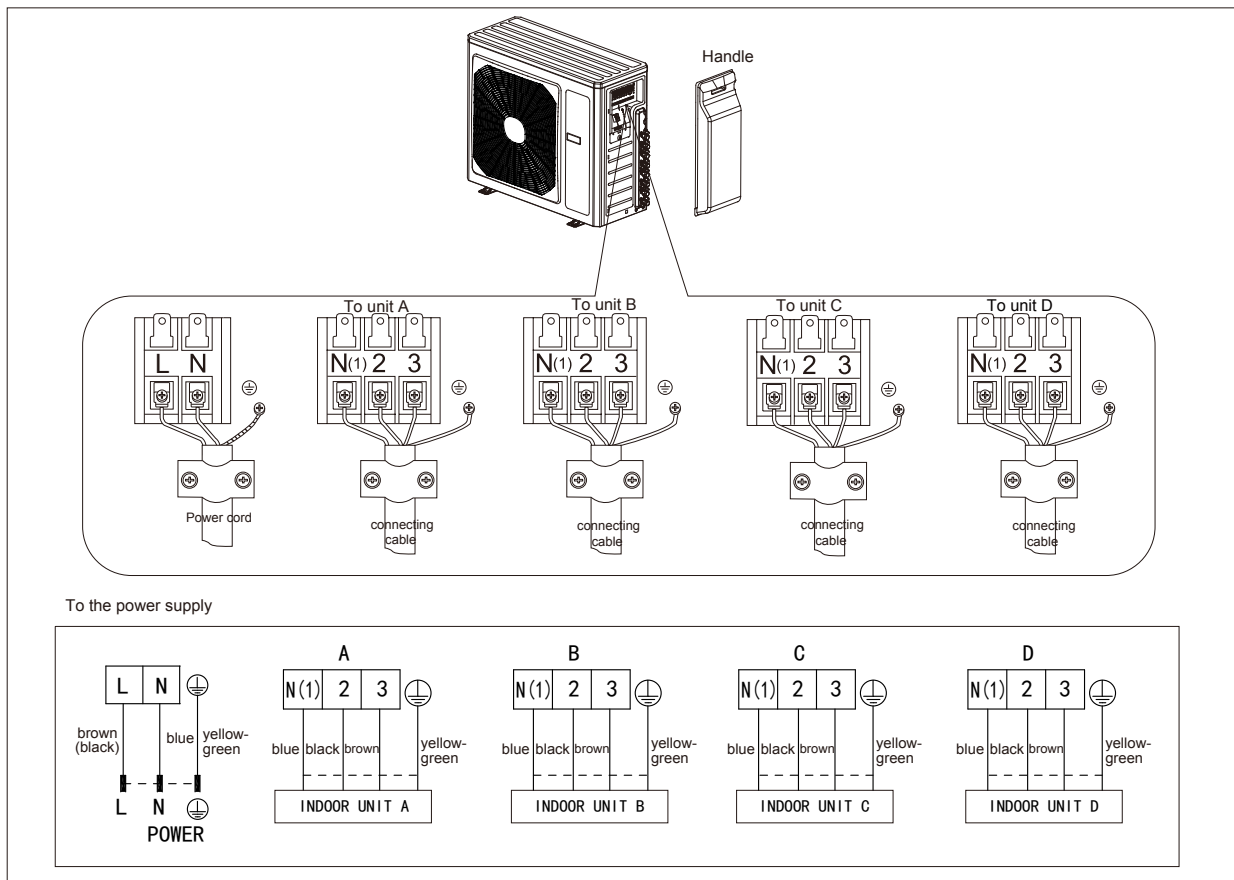

42K :

1. Remove the handle at the right side plate of the outdoor unit (one screw).
2. Remove the cable clamp, connect the power connection cable with the terminal at the row of connection and fix the connection. The fitting line distributing must be consistent with the indoor unit. terminal of line bank. Wiring should meet that of indoor unit.
3. Fix power connection wire by wire clamp.
4. Ensure wire has been fixed well.
5. Install the handle.



An all-pole disconnection switch having a contact separation of at least 3mm in all pole should be connected in fixed wiring.



Wrong wire connection may cause malfunction of some electric components. After fixing cable, ensure that leads between connection to fixed point have some space.



The connection pipes and the connecting wirings of the unit A, unit B, unit C and unit D, unit E must be corresponding to each other respective.



The appliance shall be installed in accordance with national wiring regulations.



Including an air switch with suitable capacity, please note the following table. Air switch should be included magnet buckle and heating buckle function, it can protect the circuit-short and overload. (Caution: please do not use the fuse only for protect the circuit)

Note: The above figures are only intended to be a simple diagram of the appliance and may not correspond to the appearance of the units that have been purchased.

Air-conditioner	Air switch capacity
42K	25A

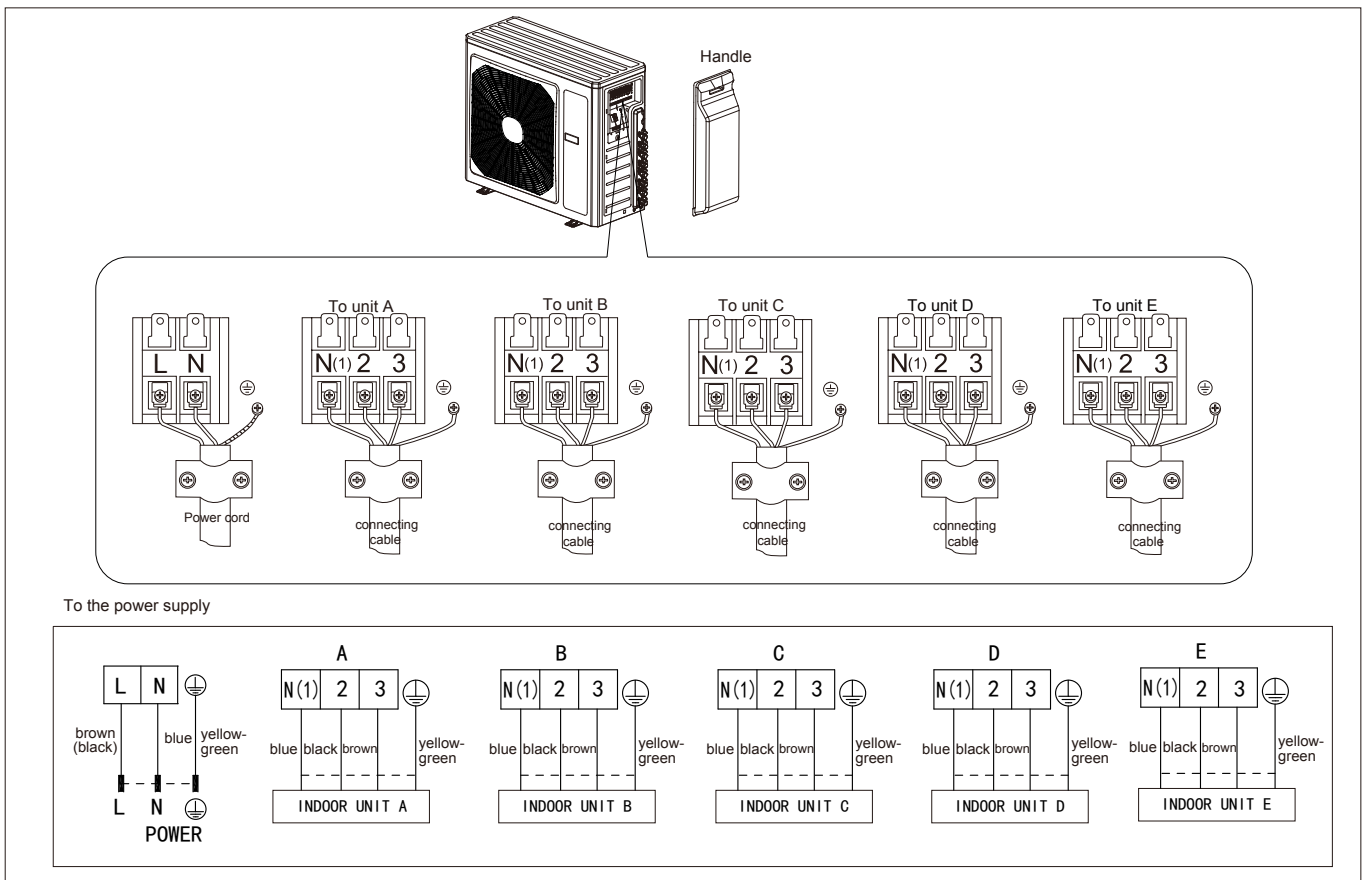

Location

- ⚠ Use bolts to secure the unit to a flat, solid floor.
- ⚠ When mounting the unit on a wall or the roof, make sure the support is firmly secured so that it cannot move in the event of intense vibrations or a strong wind.
- Do not install the outdoor unit in pits or air vents

Installing the pipes

- ⚠ Use suitable connecting pipes and equipment for the refrigerant R32.

Models(m)	14Kx2	18Kx2	21Kx3	24Kx3	28Kx4
Max. connection pipe length	20	20	60	60	70
Max. connection pipe length (Simple one indoor unit)	10	10	20	20	20

The sum of the capacity codes of the indoor units should be among 50%-150% of that of the outdoor unit.

- ⚠ The refrigerant pipes must not exceed the maximum heights 5m(14K&18K)or 10m(21K&24Kx3&28K).
- ⚠ Wrap all the refrigerant pipes and joints.
- ⚠ Tighten the connections using two wrenches working in opposite directions.

Caution: Installation Must be Performed in Accordance with the NEC/CEC by Authorized Personnel Only.

Install the drain fitting and the drain hose (for model with heat pump only)

Condensation is produced and flows from the outdoor unit when the appliance is operating in the heating mode. In order not to disturb neighbours and to respect the environment, install a drain fitting and a drain hose to channel the condensate water. Install the drain fitting and rubber washer on the outdoor unit chassis and connect a drain hose to it as shown in the figure.

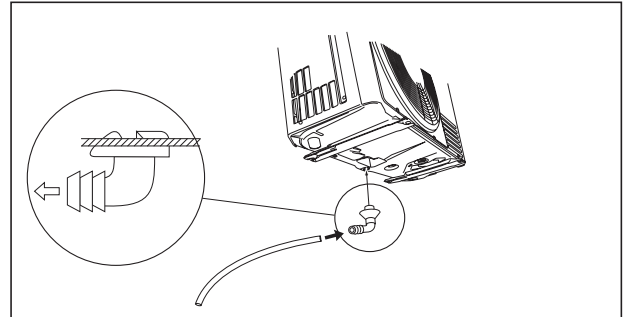

BLEEDING

Humid air left inside the refrigerant circuit can cause compressor malfunction. After having connected the indoor and outdoor units, bleed the air and humidity from the refrigerant circuit using a vacuum pump.

- (1) Unscrew and remove the caps from the 2-way and 3-way valves.
- (2) Unscrew and remove the cap from the service valve.
- (3) Connect the vacuum pump hose to the service valve.
- (4) Operate the vacuum pump for 10-15 minutes until an absolute vacuum of 10 mm Hg has been reached.
- (5) With the vacuum pump still in operation, close the low-pressure knob on the vacuum pump coupling. Stop the vacuum pump.
- (6) Open the 2-way valve by 1/4 turn and then close it after 10 seconds. Check all the joints for leaks using liquid soap or an electronic leak device.
- (7) Turn the body of the 2-way and 3-way valves. Disconnect the vacuum pump hose.
- (8) Replace and tighten all the caps on the valves.

Diameter (mm)	Twisting moment (N.m)
Φ6	15-20
Φ9.52	35-40
Φ16	60-65
Φ12	45-50
Φ19	70-75

18K unit need to be installed the indoor unit

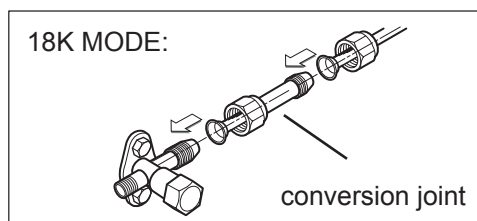

INSTALLER

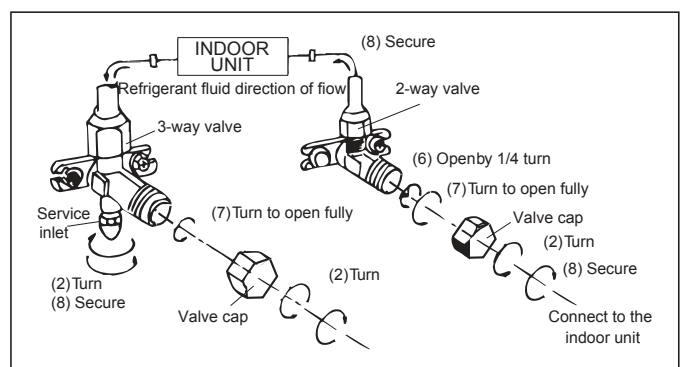
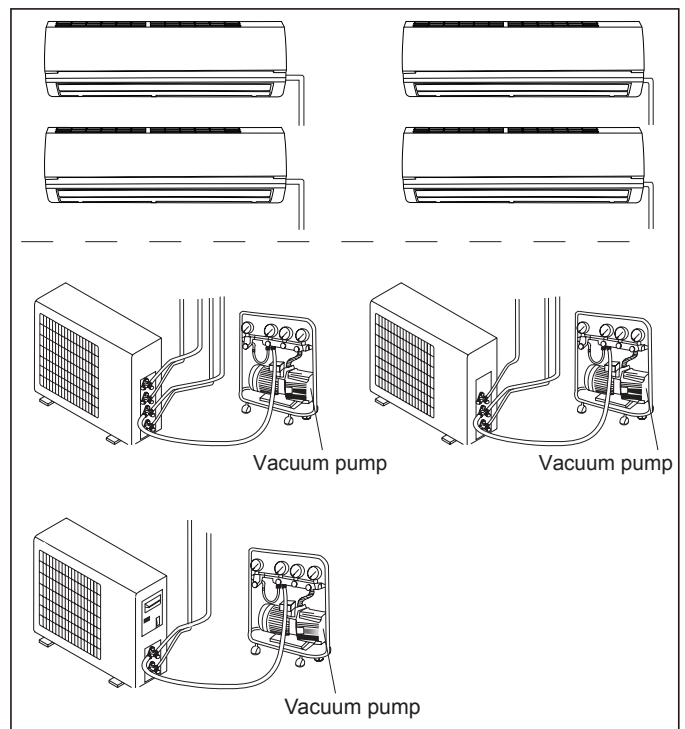

- ⚠ Use suitable instruments for the refrigerant R32.
- Do not use any other refrigerant than R32.
- ⚠ Do not use mineral oils to clean the unit.

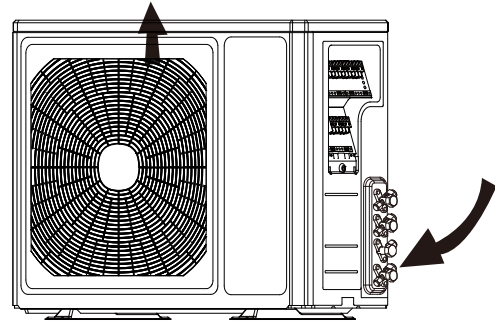

INSTALLATION DIMENSION DIAGRAM

- ⚠ The installation must be done by trained and qualified service personnel with reliability according to this manual.
- ⚠ Contact service center before installation to avoid the malfunction due to unprofessional installation.
- ⚠ When picking up and moving the units, you must be guided by trained and qualified person.
- ⚠ Ensure that the recommended space is left around the appliance.

MTS2R-18HDI
21K

24K MTS4R-28HDI
36K 42K

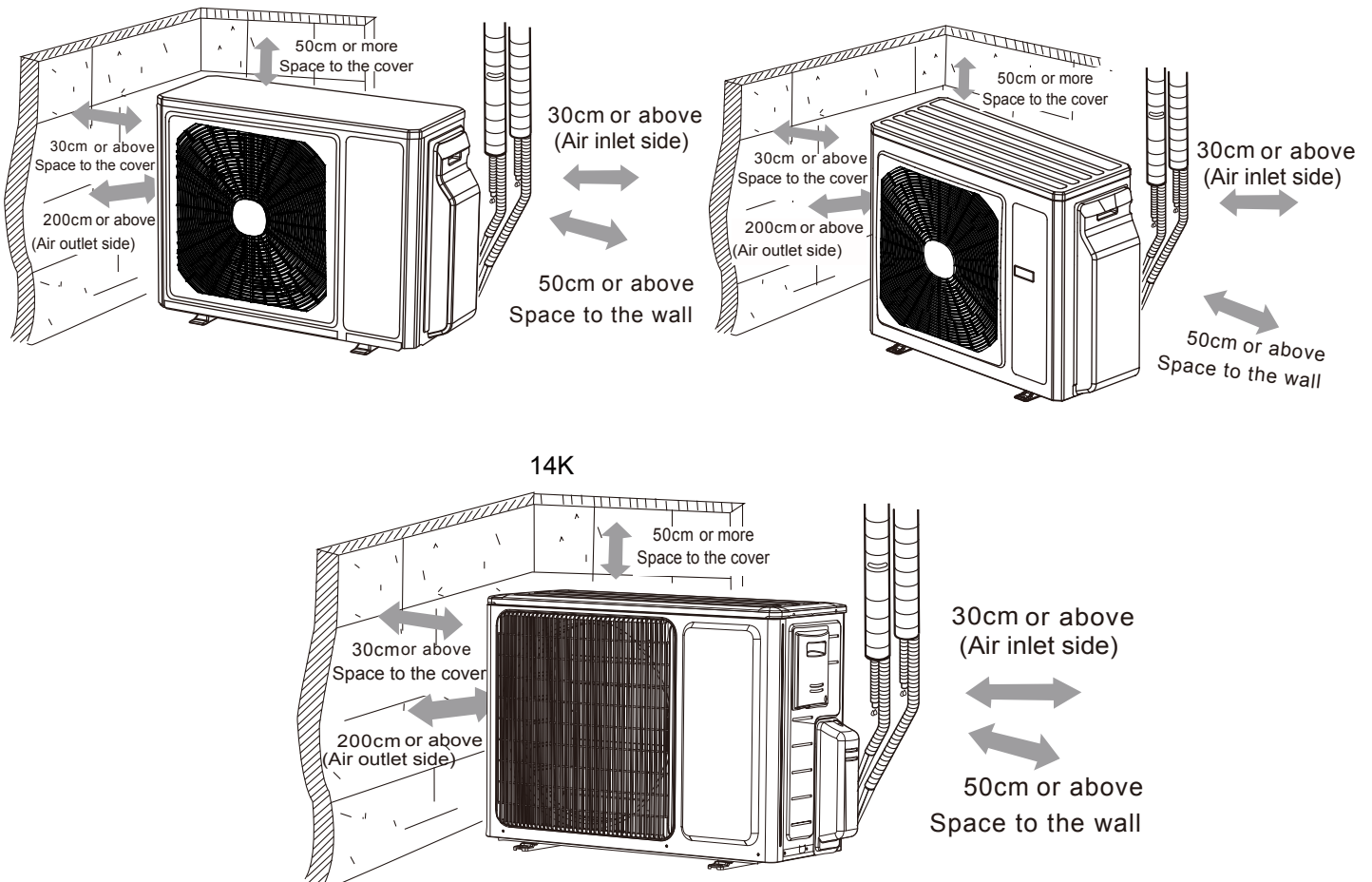

Check Items	Problems Owing to Improper Installation
Is the installation reliable?	The unit may drop, vibrate or make noises
Has the gas leakage been checked?	May cause unsatisfactory cooling (heating) effect
Is the thermal insulation of the unit sufficient?	May cause condensation and water dropping
Is the drainage smooth?	May cause condensation and water dropping
Does the power supply voltage accord with the rated voltage specified on the nameplate?	The unit may bread down or the components may be burned out
Are the lines and pipelines correctly installed?	The unit may bread down or the components may be burned out
Has the unit been safely grounded?	Risk of electrical leakage
Are the models of lines in conformity with requirements?	The unit may bread down or the components may be burned out
Are there any obstacles near the air inlet and outlet of the indoor and outdoor units?	The unit may bread down or the components may be burned out
Have the length of refrigerating pipe and refrigerant charge amount been recorded?	It is not easy to decide the charge amount of refrigerant.

Qualification requirement for installation and maintenance man

- All the work men who are engaging in the refrigeration system should bear the valid certification awarded by the authoritative organization and the qualification for dealing with the refrigeration system recognized by this industry. If it needs other technician to maintain and repair the appliance, they should be supervised by the person who bears the qualification for using the flammable refrigerant.
- It can only be repaired by the method suggested by the equipment's manufacturer.

Installation notes

- The air conditioner is not allowed to use in a room that has running fire (such as fire source, working coal gas ware, operating heater).
- It is not allowed to drill hole or burn the connection pipe.
- The air conditioner must be installed in a room that is larger than the minimum room area. The minimum room area is shown on the nameplate or following table a.
- Leak test is a must after installation.

table a- Minimum room area (m²)

Minimum room area(m ²)	Charge amount (kg)	≤1.2	1.3	1.4	1.5	1.6	1.7	1.8	1.9	2	2.1	2.2	2.3	2.4	2.5
	floor location	/	14.5	16.8	19.3	22	24.8	27.8	31	34.3	37.8	41.5	45.4	49.4	53.6
window mounted	/	5.2	6.1	7	7.9	8.9	10	11.2	12.4	13.6	15	16.3	17.8	19.3	
wall mounted	/	1.6	1.9	2.1	2.4	2.8	3.1	3.4	3.8	4.2	4.6	5	5.5	6	
ceiling mounted	/	1.1	1.3	1.4	1.6	1.8	2.1	2.3	2.6	2.8	3.1	3.4	3.7	4	

Maintenance notes

- Check whether the maintenance area or the room area meet the requirement of the nameplate.
 - It's only allowed to be operated in the rooms that meet the requirement of the nameplate.
- Check whether the maintenance area is well-ventilated.
 - The continuous ventilation status should be kept during the operation process.
- Check whether there is fire source or potential fire source in the maintenance area.
 - The naked flame is prohibited in the maintenance area; and the "no smoking" warning board should be hanged.
- Check whether the appliance mark is in good condition.
 - Replace the vague or damaged warning mark.

Welding

- If you should cut or weld the refrigerant system pipes in the process of maintaining, please follow the steps as below:
 - a. Shut down the unit and cut power supply
 - b. Eliminate the refrigerant
 - c. Vacuuming
 - d. Clean it with N2 gas
 - e. Cutting or welding
 - f. Carry back to the service spot for welding
- The refrigerant should be recycled into the specialized storage tank.
- Make sure that there isn't any naked flame near the outlet of the vacuum pump and it's well-ventilated.

Filling the refrigerant

- Use the refrigerant filling appliances specialized for R32. Make sure that different kinds of refrigerant won't contaminate with each other.
- The refrigerant tank should be kept upright at the time of filling refrigerant.
- Stick the label on the system after filling is finished (or haven't finished).
- Don't overfilling.
- After filling is finished, please do the leakage detection before test running; another time of leak detection should be done when it's removed.

Safety instructions for transportation and storage

- Please use the flammable gas detector to check before unload and open the container.
- No fire source and smoking.
- According to the local rules and laws.

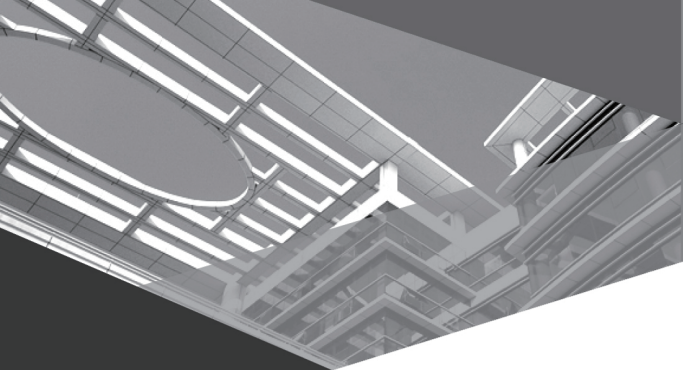

TQSDT

GREE ELECTRIC APPLIANCES, INC. OF ZHUHAI

Add: West Jinji Rd, Qianshan, Zhuhai, Guangdong, China, 519070

Tel: (+86-756) 8522218

Fax: (+86-756) 8669426

E-mail: gree@gree.com.cn www.gree.com



66129930487