



## OWNER'S MANUAL

# HEAT PUMP WATER HEATER

---



Read this owner's manual thoroughly before operating the appliance and keep it handy for reference at all times.

Original instruction

EN ENGLISH

FR FRANÇAIS

ES ESPAÑOL

DE DEUTSCH

IT ITALIANO

PL POLSKI



MFL71409202  
Rev.02\_112320



[www.lg.com](http://www.lg.com)

Copyright © 2020 LG Electronics Inc. All Rights Reserved.

# TABLE OF CONTENTS

This manual may contain images or content different from the model you purchased.

This manual is subject to revision by the manufacturer.

<b>SAFETY INSTRUCTIONS .....</b>	<b>3</b>
Safety Precaution .....	4
<b>INSTALLATION .....</b>	<b>12</b>
Parts and Functions .....	12
Installation Tools .....	13
Accessories .....	13
Installation Instructions .....	14
Select the best Location .....	15
Unpacking and Removing Shipping Bolts .....	16
Thermal Expansion .....	16
Installing Drain Valve .....	16
Installing T&P Relief Valve .....	16
Installing Condensate Drain Lines .....	18
Connecting the Water Supply .....	19
Making Electrical Connections .....	20
Safety Controls .....	21
Insulation Blanket Kits .....	21
Installation Checklist .....	22
<b>OPERATION .....</b>	<b>23</b>
Using Basic Control .....	23
<b>SMART FUNCTIONS .....</b>	<b>25</b>
LG ThinQ Application .....	25
<b>MAINTENANCE .....</b>	<b>27</b>
Draining and Flushing the Water Heater .....	27
T&P Relief Valve Maintenance .....	28
Air Filter Maintenance .....	28
Condensate Drain Maintenance .....	29
Shut-down for an Extended Period .....	29
<b>TROUBLESHOOTING .....</b>	<b>30</b>
Before Calling for Service .....	30
Error Code .....	32
Replacement Parts List .....	33
Technical specification .....	35

**Your safety and the safety of others are very important.**

We have provided many important safety messages in this manual and on your appliance. Always read and follow all safety messages.



This is the safety alert symbol.

This symbol alerts you to potential hazards that can kill or injure you and others. All safety messages will follow the safety alert symbol and either the word **DANGER**, **WARNING** or **CAUTION**. These words mean:



## **CAUTION**

You may be slightly injured or cause damage to the product if you do not follow instructions.



## **WARNING**

You may be killed or seriously injured if you do not follow instructions.



## **DANGER**

This indicates that the failure to follow the instructions will cause serious injury or death.

All safety messages will tell you what the potential hazard is, tell you how to reduce the chance of injury, and tell you what may happen if the instructions are not followed.

**⚠ WARNING**

To reduce the risk of explosion, fire, death, electric shock, injury or scalding to persons, instructions in this manual must be followed.

Be sure to fully understand the user's manual before you install and operate this appliance. If you have any difficulty in understanding or following the instructions in this manual, or have any questions, contact an authorized service center or the local electric utility.

**Safety Precaution****Water Temperature Setting****⚠ DANGER**

Water temperature above 50 °C can cause severe burns instantly or death from scalding. Be sure to read and follow the warnings on the picture below.

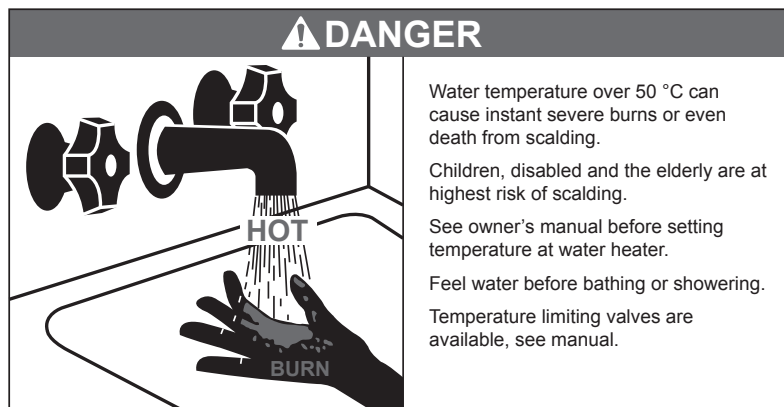

For determining the proper water temperature for your home, refer to the chart below.

Temperature	Time to Produce a Serious Burn
49 °C	More than 5 minutes
52 °C	1 ½ to 2 minutes
54 °C	About 30 seconds
57 °C	About 10 seconds
60 °C	Less than 5 seconds
63 °C	Less than 3 seconds
65 °C	About 1 ½ seconds
68 °C	About 1 second

#### NOTE

- To reduce point of use water temperature, Thermostatic Mixing Valves are recommended. These valves automatically mix hot and cold water in branch water lines. It is recommended to use a mixing valve.

#### DANGER

Households with the elderly, children, or people with disabilities may require a 48 °C or lower thermostat setting to prevent contact with “HOT” water.

#### DANGER

##### Higher water temperature increases the potential for Hot Water SCALDS

Water temperature in the heater is regulated by the buttons on display. The water temperature of this water heater is factory set to 50 °C to comply with safety regulations. For information about adjusting the water temperature, refer to the operation section in this manual.

## Local Installation Regulations

This appliance must be installed accordance with instructions of this manual, national regulations, and any regulations issued by local authorities and public health bodies.

## IMPORTANT SAFETY INSTRUCTIONS

### **WARNING**

**To reduce the risk of explosion, fire, death, electric shock, scalding or injury to persons when using this product, follow basic precautions, including the following:**

### **Children in the Household:**

This appliance is not intended for use by persons (including children) with reduced physical, sensory or mental capabilities, or lack of experience and knowledge, unless they have been given supervision or instruction concerning use of the appliance by a person responsible for their safety. Children should be supervised to ensure that they do not play with the appliance. Take care so that children may not step on the product. Otherwise, children may be seriously injured due to falling down.

### **For use in Europe:**

This appliance can be used by children aged from 8 years and above and persons with reduced physical, sensory or mental capabilities or lack of experience and knowledge if they have been given supervision or instruction concerning use of the appliance in a safe way and understand the hazards involved. Children shall not play with the appliance. Cleaning and user maintenance shall not be made by children without supervision.

## Installation

- To reduce the risk of severe injury or death, follow all installation instructions.
- Be sure your appliance is properly installed in compliance with local codes and the provided installation instructions.
- Do not replace any part of your water heater and use only original accessories and spare part unless it is specifically recommended in this manual.
- Do not turn on the electrical power to water heater unless the tank is completely full of water.
- Never attempt to operate this appliance if it is damaged, malfunctioning, partially disassembled, or has missing or broken parts.
- When the product is soaked (flooded or submerged) in water, contact an Authorized Service Center for repair before using it again.
- Moving or installation of the appliance requires two or more people.
- Turn off the power by opening the circuit breaker or removing the fuses before installing.
- Even if the water heater thermostat is set to relatively low, hot water has the potential for scalding. To reduce the risk of scalding, thermostatic mixing valves are recommended.
- Keep packing materials out of the reach of children. Packaging material can be dangerous for children. There is a risk of suffocation.
- Destroy the carton, plastic bag, and other packing materials after the appliance is unpacked. Children might use them for play. Cartons covered with rugs, bedspreads, or plastic sheets can become airtight chambers.
- Connect to a properly rated, protected, and sized power circuit to avoid electrical overload.

- This appliance must be positioned near to an electrical power supply. Use a power supply of 1.5 mm<sup>2</sup> or more in the nominal cross-sectional area
- Do not install the water heater on an unstable surface or in a place where there is danger of it falling.
- For installation, always contact the dealer or an Authorized Service Center. There is risk of fire, electric shock, explosion or injury.
- Do not install the water heater in a place where flammable liquids or gases such as gasoline, propane, paint thinner, etc., are stored.
- Always ground the product. There is risk of fire or electric shock
- Install the panel and the cover of the control box safety.
- Do not touch heat exchanger fins with your bare hands. Otherwise, you may get a cut in your hands.
- Do not input air or gas into the system except with the specific refrigerant.
- Do not turn on the circuit breaker or power when covers are removed or opened.
- Make the connection securely so that screw in terminals may not be loosed when pulling cable.

## Operation

- Use this appliance only for its intended purpose.
- If the water heater has been subjected to fire, flood or physical damage, disconnect all power to water heater immediately, and DO NOT operate it again until it has been inspected by a qualified person.
- Do not turn on the water heater unless the tank is completely full of water.
- Do not turn on the water heater if cold water supply shut-off valve is closed.



- Feel water before bathing or showering.
- Even at 50 °C, hot water can scald.
- Do not block the inlet or outlet of air flow.
- Never touch, operate, or repair the water heater with wet hands.
- Do not leave flammable substances such as gasoline, benzene, or thinner near the water heater. (Do not install the unit in potentially explosive atmospheres.)
- Cut off the power supply if there is any noise, smell, or smoke coming from the water heater.
- Make sure that the power cable is neither dirty, loose, nor broken.
- Do not place any objects on the power cable.
- Do not modify or extend the power cable. Scratches or peeling insulation on the power cables may result in fire or electric shock, and should be replaced.
- The supply cord cannot be replaced. If the cord is damaged the appliance should be scrapped.
- Do not expose people, animals, or plants to the cold wind from the water heater for extended periods of time.
- Take care to ensure that power cable could not be pulled out or damaged during operation. There is risk of fire or electric shock.
- Do not touch refrigerant pipe, water pipe and any internal parts while the unit is operating or immediately after operation. There is risk of burns or frostbite, personal injury.
- Additional refrigerant injection is not possible.

## **Maintenance**

- If the supply cord is damaged, it must be replaced by the manufacturer, its service agent or similarly qualified persons in order to avoid a hazard.

- Disconnect this appliance from the power supply before cleaning and attempting any user maintenance.
- Before draining water heater, turn off the power to product.
- Do not turn on the electrical power to the water heater unless the tank is completely full of water.

### Technical Safety

- Installation or repairs made by unauthorized persons can pose hazards to you and others.
- The information contained in the manual is intended for use by a qualified service technician who is familiar with the safety procedures and equipped with the proper tools and test instruments.
- Failure to read and follow all instructions in this manual can result in equipment malfunction, property damage, personal injury and/or death.

#### CAUTION

**To reduce the risk of minor injury to persons, malfunction, or damage to the product or property when using this product, follow basic precautions, including the following:**

### Installation

- Install the product on a firm and level floor.
- Do not install the water heater in a place where leakage of the tank or connections will result in damage to the area adjacent to it or to lower floors of the structure. Where such areas cannot be avoided, it is recommended that a suitable drain pan, adequately drained, be installed under the water heater.

- Install the product so that the noise or hot wind from the appliance may not cause any damage to the neighbors. Otherwise, it may cause dispute with the neighbors.
- Install the drain hose properly for the smooth drainage of water condensation.
- Always inspect gas leakage after the installation and repair of product. Otherwise, it may cause the failure of product.
- In order to avoid a hazard due to inadvertent resetting of the thermal cut-out, this appliance must not be supplied through an external switching device, such as a timer, or connected to a circuit that is regularly switched on and off by the utility.

### **Operation**

- Do not step on the product and do not put anything on it.
- Do not use this appliance if any part have been underwater. Immediately contact an Authorized Service Center for replace flooded water heater. Do not attempt to repair the unit. It must be replaced.
- Turn off the power and water supply to water heater and drain water heater if the appliance is to be left for an extended period of time, such as during vacations.

# INSTALLATION



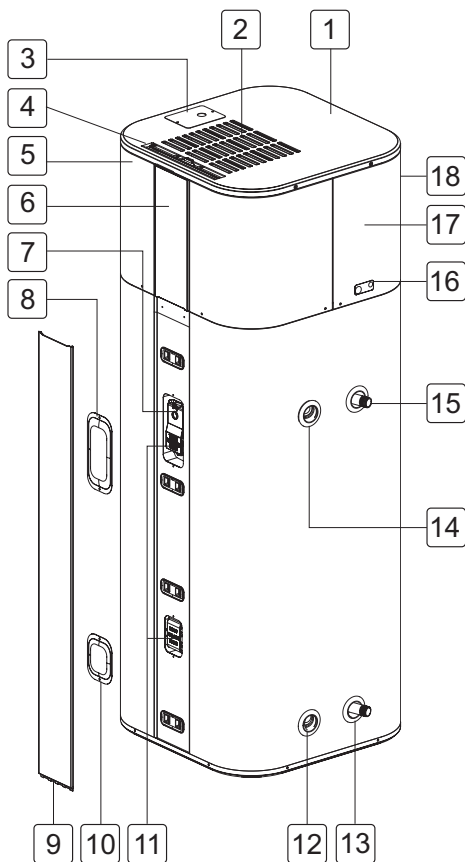

EN

## Parts and Functions

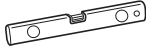

- 1 Top cover
- 2 Air intake vents
- 3 Junction box
- 4 Air filter
- 5 Front panel
- 6 Display decor / Control panel
- 7 ECO
- 8 Upper element cover
- 9 Front decor
- 10 Lower element cover
- 11 Heating element
- 12 Opening for drain valve
- 13 Water inlet
- 14 Opening for T&P relief valve
- 15 Water outlet
- 16 Condensate drain
- 17 Rear panel
- 18 Air outlet Vents

## Installation Tools



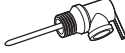

Figure	Name	Figure	Name
	Screw driver		Teflon tape
	Spanner		Level
	Multi-meter		

## Accessories

Included Accessories:

Figure	Name	Figure	Name
	Drain valve		T&P relief valve

Recommended Accessories:

Figure	Name	Figure	Name
	Drain pan		Thermal expansion tank
	Pressure reducing valve		Thermostatic mixing valve

## Installation Instructions

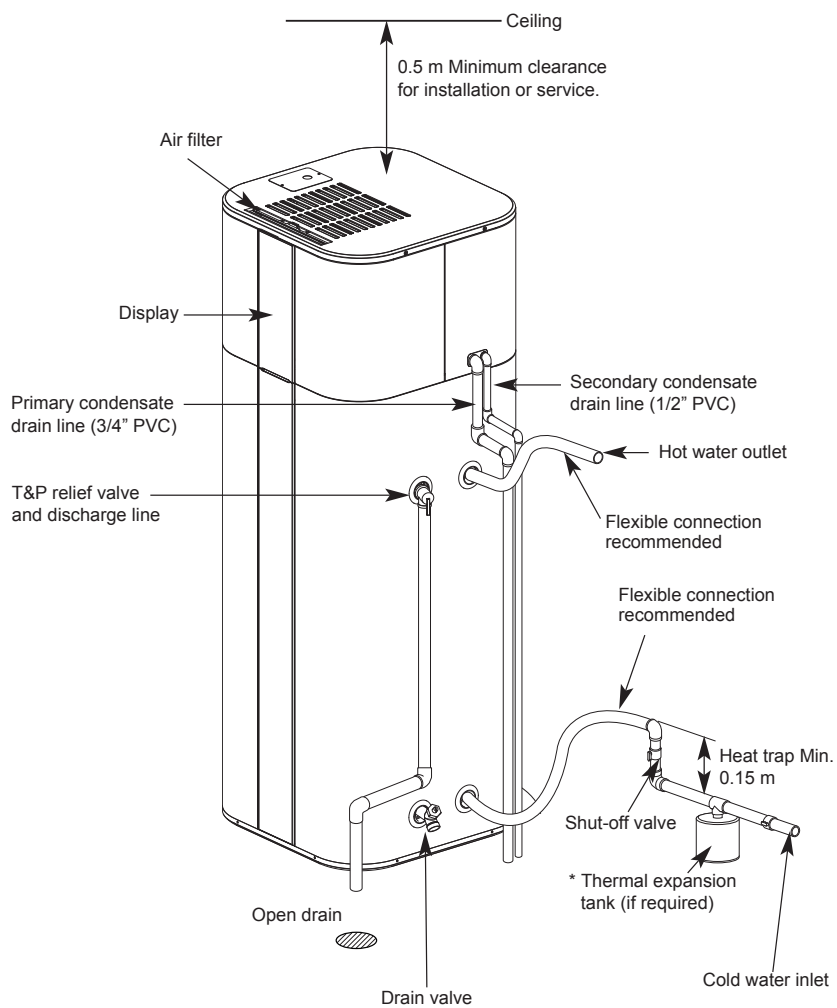

\* In closed system, connect a thermal expansion tank to cold water supply line. See "Thermal Expansion" Section (p.16).

## Select the best Location

### NOTE

- Installation in a confined space without proper ventilation will lead to higher power consumption.
- Auxiliary drain pan **MUST** be installed in compliance with local codes. Drain pan kits are available from the store where the water heater purchased, or any water heater distributor. Drain pan should not obstruct cold water inlet or drain valve.
- Select space where has enough space for periodic servicing. The air filter, covers, and front panels can be removed to permit inspection and servicing.
- Take the weight of the water heater into account and select a place where the floor is strong enough to support the weight of full water heater.
- The water heater and water lines should be protected from freezing and high corrosive elements. Do not install water heater in outdoor or unprotected areas.
- Install the water heater close to the area of the greatest heater water demand and the center of plumbing system. Long uninsulated hot water lines can waste energy.
- Insufficient air exchange will result in increased energy consumption level.
- The installation site must be over 1 °C.

Ensure the water heater is horizontal using a spirit level.

Keep level parallel in installing the product. Otherwise, it may cause vibration or water leakage. It may cause injury or an accident.

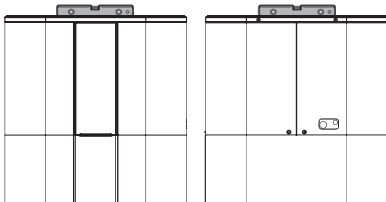

### Minimum Clearances

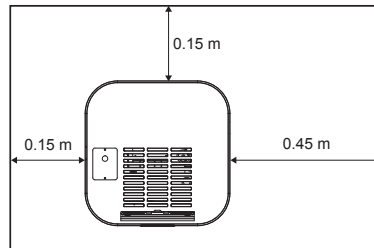
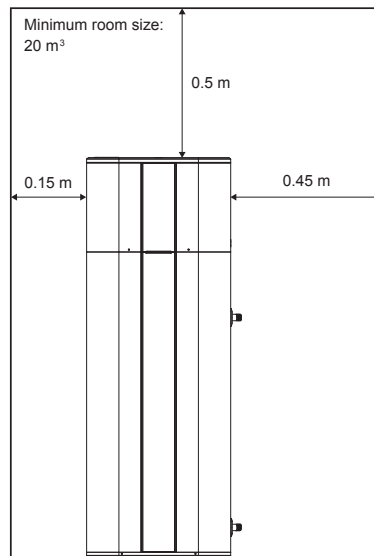

### NOTE

- For future service, a minimum 1 m clearance between any object and the left, right and back side is recommended.

## Unpacking and Removing Shipping Bolts

### NOTE

- Accessories (drain valve and T&P relief valve) are attached on pallet. Keep it for installation.

Unpack all shipping materials from the water heater for proper operation and inspect it for shipping damage.

- 1 Remove carton and shipping materials.
- 2 Remove the screws from the shipping brackets.

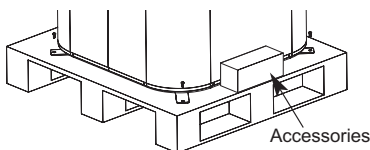

- 3 Pull out the shipping brackets.

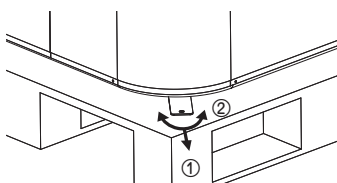

- 4 Slightly tip the water heater and carefully roll the water heater off the pallet.

## Thermal Expansion

Determine if a check valve is present on the inlet water line. Check with your local water utility. A check valve located in cold water inlet line will create a "closed water system".

As water is heated, it creates an increase in pressure within the water system because the increased volume of water doesn't have a place to go.

Referred to as "thermal expansion", the rapid pressure increase can quickly reach the safety setting of the relief valve.

This will cause the relief valve to open during each heating cycle. We recommend installing an expansion tank to control thermal expansion.

Connect the thermal expansion tank to the cold water supply line (see Installation Instructions).

For additional information, contact installing contractor, plumbing inspector, or water supplier.

### NOTE

- Drain valve and T&P relief valve is included in packing box of the water heater. They must be installed in the opening provided for this purpose.

## Installing Drain Valve

- 1 Apply Teflon tape on the G end to prevent leaking.

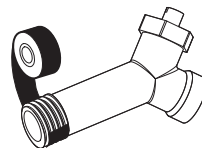

- 2 Install the drain valve in the opening marked "Drain Valve".

## Installing T&P Relief Valve

Use T&P relief valve included in packing.

- 1 Apply Teflon tape on the G end to prevent leaking.

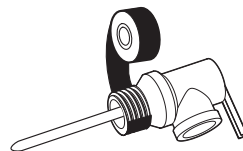

- 2 Install the T&P relief valve in the opening marked T&P relief valve.



## Connecting T&P Relief Valve Discharge Pipe

### WARNING

The pressure rating of the relief valve must not exceed 1 MPa, the maximum working pressure of the water heater as specified on the data plate.

### WARNING

DO NOT connect any valve or other restriction to the T&P plumbing. DO NOT connect the T&P plumbing to the condensate plumbing. It must be directly piped to an adequate open drain.

Install T&P Relief Valve discharge pipe according to local codes and the following instructions.

- The inside diameter of the discharge pipe must be at least 3/4".
- The discharge pipe must be approved for hot water distribution and withstand 100 °C without distortion.
- The end of the discharge pipe should not be threaded or concealed and should be protected from freezing.
- Do not insert or install any type of valve, restriction, or reducer coupling in the discharge pipe.

- 1 Apply Teflon tape on the G end to prevent leaking.

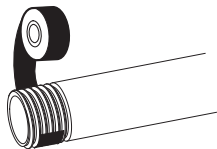

- 2 Attach the discharge pipe to outlet of the T&P relief valve. The discharge pipe must pitch downward from the valve to allow complete drainage of both T&P relief valve and discharge pipe.

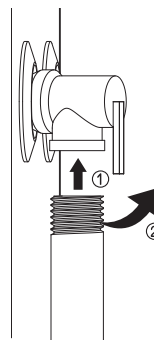

- 3 The end of the discharge pipe must be piped to an adequate open drain.



- \* The water may drip from the discharge pipe of the pressure-relief device and that this pipe must be left open to the atmosphere.
- \* The pressure-relief device is to be operated regularly to remove lime deposits and to verify that it is not blocked.
- \* A discharge pipe connected to the pressure-relief device is to be installed in a continuously downward direction and in a frost-free environment.

## Installing Condensate Drain Lines

### NOTE

- When making drain fitting connections to the drain tubing, **DO NOT** overtighten. Overtightening fittings could crack or damage the condensate drain pan.
- Condensate from this unit is not acidic.

The condensate drain lines and connections to the drain piping must meet state and local codes.

Do not reduce the drain line size to less than the condensate connection size provided.

Ensure that the condensate drain lines maintain a downward slope for proper drainage.

The drain line should be insulated to prevent condensation from forming on the outside of the drain line.

If no floor drain is available or the drain is above the level of the condensate line, then a common condensate pump with a capacity no less than 7.5 L per day must be installed.

- 1 Apply Teflon tape on the G end to prevent leaking.

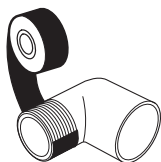

- 2 Attach elbow with 3/4" slip & 3/4"G to the primary drain connection.

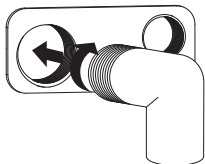

- 3 Using an approved sealant, insert the PVC pipe into the female end. Condensate drain must be piped to an adequate drain.

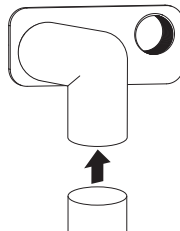

- 4 Using 1/2" PVC piping, an elbow with 1/2" slip & 1/2" G, and an approved sealant, attach the elbow to secondary drain connection and insert the PVC pipe into the female end.

## Connecting the Water Supply

### NOTE

- DO NOT directly solder or braze to hot or cold water connections. If sweat connections are used, sweat tubing to adapter before installing the adapter to the hot or cold water connections on heater. Any heat applied to the water supply fittings will permanently damage the internal plastic lining in these ports.

\* The maximum pressure in cold water supply line is 0.8 MPa. If the supply water is greater than 0.8 MPa, install a pressure reducing valve.

\* Connect the water for filling or refilling the heating system as specified by EN1717/ EN 61770 to avoid contamination of drinking water by return flow.

Maximum and minimum water operating temperatures (°C)	35 / 62
Maximum and minimum water operating pressure (MPa)	- / 0.8

Refer to "Installation Instructions" for suggested typical installation.

- 1 Check the type of water pipes in your home. Use fittings adequate for the type of pipe in your home.
- 2 Apply Teflon tape on the G end to prevent leaking.

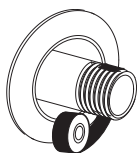

- 3 Connect cold and hot water supply using 3/4" G.

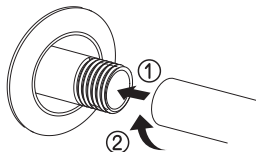

For ease of disconnecting the water heater for service or replacement, the installation of unions is recommended on the water connections.

- 4 Install a shut-off valve in the cold water line near the water heater.
- 5 Install the insulation on the cold and hot water pipes. Insulating hot water pipe can increase energy efficiency.

### To Fill the Water Heater

#### **! WARNING**

**Do not turn on the electrical power to water heater unless the tank is completely full of water. The water heater warranty does not cover damage or failure resulting from operation with empty or partially empty tank.**

- 1 Make sure that the drain valve on water heater is completely closed.

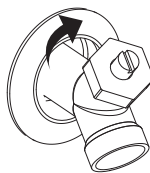

- 2 Turn on the cold water supply
- 3 Open each hot water faucet slowly and allow the water to run until it flows with a full stream.
- 4 Let the water run full stream for a few minutes.

## Making Electrical Connections

### **! WARNING**

Disconnect all power before working on any electrical connections.

### **! WARNING**

The ground connection is mandatory.

### **! WARNING**

Never supply power to heating element directly. Upper and lower heating elements are installed on the product.(230 V, 2 kW)

### NOTE

- All wiring must conform to European and national standards, and must be protected by a 30 mA RCD(Residual current device).
- Means for disconnection must be incorporated in the fixed wiring in accordance with the wiring rules

The water heater must be permanently powered by electricity to ensure correct operation of the impressed current titanium anode (ICCP).

Do not turn on power until water heater is completely filled.

The appliance can only be connected and operated on a single-phase 230 V AC grid.

The electrical installation will include:

- The installation of a residual current device (RCD) having a rated residual operating current not exceeding 30 mA is advisable.
- The rating of the residual current device (RCD) to be installed

The supply cord cannot be disconnected from the product.

The supply cord cannot be replaced. If the cord is damaged the appliance should be scrapped.

### **! CAUTION**

In order to avoid a hazard due to inadvertent resetting of the thermal cut-out, this appliance must not be supplied through an external switching device, such as a timer, or connected to a circuit that is regularly switched on and off by the utility.

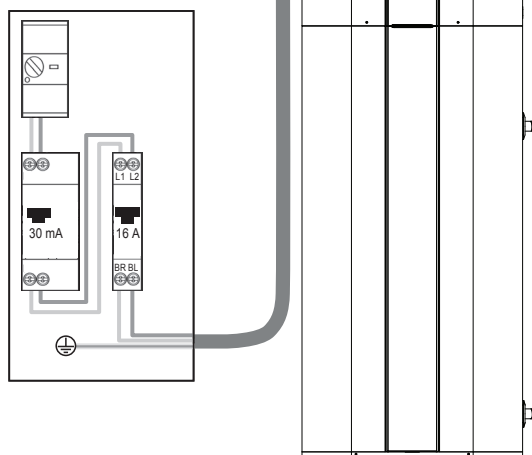

## Safety Controls

### CAUTION

**You must have a qualified person investigate the cause of the high temperature condition and take corrective action before placing the water heater in service again.**

There is temperature limiting control(ECO) that is located above the upper heating element. If the water temperature becomes excessively high, the temperature limiting control(ECO) shuts off the power to the heating elements.

Once the control opens, it must be reset manually.

To reset temperature limiting control(ECO):

- 1** Turn off the power by opening the circuit breaker or removing the fuses.
- 2** Remove the front decor and upper element cover.
- 3** Press the red ECO RESET button.

## Insulation Blanket Kits

External insulation blanket, available to the general public, for water heater is not necessary.

The manufacturer's warranty does not cover any damage or failure caused by installing or using any type of unauthorized energy-saving or other devices.

The manufacturer is not responsible for any injury or loss resulting from the use of such unauthorized devices.

### CAUTION

**If local codes require application of any external insulation blanket kit to water heater, it will require careful attention so as not to restrict the proper function and operation of this appliance:**

- DO NOT block the air openings of the water heater.
- DO NOT cover or attempt to relocate the information or warning labels attached to the water heater.
- DO NOT cover the control panel, T&P relief valve, drain valve, and junction box.
- Inspect the blanket frequently.

## Installation Checklist

### Location

- Sufficient room for air exchange and periodic service.
- Floor is strong enough to support water heater.
- Indoor and protected from high corrosive elements.
- Close to the area of heater water demand.
- Over 1 °C.
- Area free of flammable liquids and gases.

### Drain valve

- Drain valve properly installed.

### T&P relief valve

- T&P relief valve properly installed.
- Discharge line maintains a downward slope and runs to adequate drain.
- Discharge pipe protected from freezing.

### Condensate Drain

- Drain lines maintain a downward slope and run to adequate drain.

### Water supply

- Tank is completely full of water.
- Remove air from water heater and piping.
- Water connections tight and free of leakage.
- Flexible water connections recommended.

### Wiring

- Power supply voltage agree with rating voltage on data plate.
- Proper size of branch circuit wire and fusing or circuit breaker.
- Unit properly grounded.

# OPERATION

EN

## Using Basic Control

### DISPLAY SCREEN

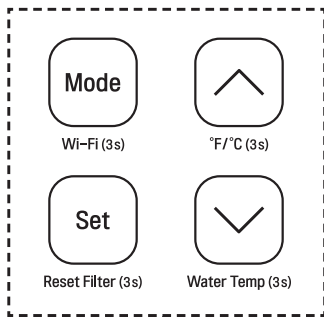
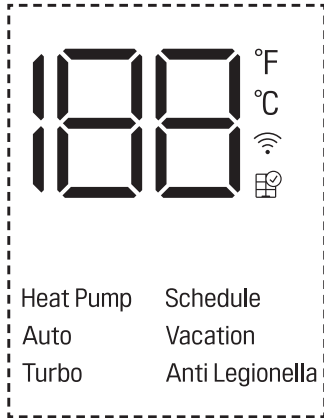



1 Button	2 Display Screen	Description
Mode	Heat Pump	To select the heat pump mode.
	Auto	To select the auto mode.
	Turbo	To select the turbo mode.
	Vacation	To select the Vacation mode.
-	Schedule	Set schedule mode only in LG ThinQ application.
-	Anti Legionella	To select the Anti Legionella mode.
Set	-	To set the desired water temperature.
↑ ↓	88	To adjust the desired water temperature.
Wi-Fi (3s)	Wi-Fi	To enable the Wi-Fi pairing.
Reset Filter (3s)	Filter icon	To reset the filter alarm.
°F/°C (3s)	°F °C	To change unit between °F and °C.
Water Temp (3s)	88	To display the current water temperature for 5 seconds.

## Water Temperature Adjustment

### **DANGER**

**Higher water temperature increases the potential for Hot Water SCALDS.**

The water temperature will be maintained according to the setting temperature on Display and can be adjusted from 35 °C to 60 °C.

- 1 Press  or  button to select the water temperature.
- 2 Press **Set** button to finish.

### Operation Mode

- Press **Mode** button repeatedly to select the operating mode. The active mode is displayed on the display screen.

#### HEAT PUMP MODE

This mode minimizes power consumption by using only heat pump for heating, but has low recovery.

#### AUTO MODE

This mode is factory set mode for shipping. This mode provides relatively low power consumption and high recovery. This mode primary uses heat pump for heating. Heating elements will provide supplementary heating, if demand is more than the heat pump can keep up by itself.

#### TURBO MODE

This mode provides the highest recovery. This mode uses heat pump and heating element simultaneously.

#### VACATION MODE

This feature is recommended when the water heater is not in used for an extended period of time. In this mode, tank temperature will be maintained at about 20 °C to minimize energy consumption and prevent the water heater from freezing.

The vacation duration can be set or modified between 1 and 90 days via LG ThinQ app.

### SCHEDULE MODE

This mode can set only in LG ThinQ application. You can escape this mode by pressing any button on the water heater.

### ANTI-LEGIONELLA MODE

The water heater automatically performs the anti-legionella mode once a week. The water temperature will go up to 60 °C and stay for 1 hour. These temperature can scald, so we recommend you use a thermostatic mixing valves. (Default inactive)

Active / Inactive

- Press and hold **Set** button about 3 seconds to set the anti-legionella mode active or inactive
- Active: (Display Blinks "Anti-legionella" "Anti-legionella" x 4)
- \* Once a week operation
- Inactive: (Display Blinks "Anti-legionella" x 4)

### Reset the Air Filter Alarm

The device will display alarm (  ) reminding you to check and clean the air filter periodically.

- Press and hold **Set** button about 3 seconds to reset the alarm.

### Change Temperature Unit

Temperature unit display on Screen can be set to Fahrenheit or Celsius

- Press and hold  button about 3 seconds to change temperature unit.

### Current water Temperature

- Press and hold  button about 3 seconds
- Display will show current water temperature of the tank for 5 seconds.

### Wi-Fi PAIRING FUNCTION

Once it is connected to the internet through a home Wi-Fi network, you can control the appliance remotely with the application for the smart phone. See "SMART FUNCTION" section for details.

- Press and hold **Mode** button about 3 seconds.

 is displayed on the display screen.



## LG ThinQ Application

This feature is only available on models with the  or **ThinQ** logo.

The **LG ThinQ** application allows you to communicate with the appliance using a smartphone.

## LG ThinQ Application Features

Communicate with the appliance from a smartphone using the convenient smart features.

### Smart Diagnosis™

If you experience a problem while using the appliance, this smart diagnosis feature will help you diagnose the problem.

### Settings

Allows you to set various options on the appliance and in the application.

### NOTE

- If you change your wireless router, internet service provider, or password, delete the registered appliance from the **LG ThinQ** application and register it again.
- The application is subject to change for appliance improvement purposes without notice to users.
- Functions may vary by model.

## Before Using LG ThinQ Application

- 1 Check the distance between the appliance and the wireless router (Wi-Fi network).
  - If the distance between the appliance and the wireless router is too far, the signal strength becomes weak. It may take a long time to register or installation may fail.

- 2 Turn off the **Mobile data** or **Cellular Data** on your smartphone.

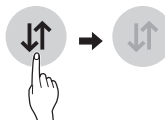

- 3 Connect your smartphone to the wireless router.



### NOTE

- To verify the Wi-Fi connection, check that  icon on the control panel is lit.
- The appliance supports 2.4 GHz Wi-Fi networks only. To check your network frequency, contact your Internet service provider or refer to your wireless router manual.
- **LG ThinQ** is not responsible for any network connection problems or any faults, malfunctions, or errors caused by network connection.
- If the appliance is having trouble connecting to the Wi-Fi network, it may be too far from the router. Purchase a Wi-Fi repeater (range extender) to improve the Wi-Fi signal strength.
- The Wi-Fi connection may not connect or may be interrupted because of the home network environment.
- The network connection may not work properly depending on the Internet service provider.
- The surrounding wireless environment can make the wireless network service run slowly.

- The appliance cannot be registered due to problems with the wireless signal transmission. Unplug the appliance and wait about a minute before trying again.
- If the firewall on your wireless router is enabled, disable the firewall or add an exception to it.
- The wireless network name (SSID) should be a combination of English letters and numbers. (Do not use special characters.)
- Smartphone user interface (UI) may vary depending on the mobile operating system (OS) and the manufacturer.
- If the security protocol of the router is set to **WEP**, you may fail to set up the network. Please change it to other security protocols (**WPA2** is recommended) and register the product again.

## Installing the LG ThinQ Application

Search for the **LG ThinQ** application from the Google Play Store or Apple App Store on a smartphone. Follow instructions to download and install the application.

## Smart Diagnosis™

Use this feature to help you diagnose and solve problems with your appliance.

### NOTE

- For reasons not attributable to LGE's negligence, the service may not operate due to external factors such as, but not limited to, Wi-Fi unavailability, Wi-Fi disconnection, local app store policy, or app unavailability.
- The feature may be subject to change without prior notice and may have a different form depending on where you are located.

## Using LG ThinQ to Diagnose Issues

If you experience a problem with your Wi-Fi equipped appliance, it can transmit troubleshooting data to a smartphone using the **LG ThinQ** application.

- Launch the **LG ThinQ** application and select the **Smart Diagnosis™** feature in the menu. Follow the instructions provided in the **LG ThinQ** application.

## Open Source Software Notice Information

To obtain the source code under GPL, LGPL, MPL, and other open source licenses, that is contained in this product, please visit <http://opensource.lge.com>.

In addition to the source code, all referred license terms, warranty disclaimers and copyright notices are available for download.

LG Electronics will also provide open source code to you on CD-ROM for a charge covering the cost of performing such distribution (such as the cost of media, shipping, and handling) upon email request to [opensource@lge.com](mailto:opensource@lge.com). This offer is valid for a period of three years after our last shipment of this product. This offer is valid to anyone in receipt of this information.

## **WARNING**

**Turn off the power by opening the circuit breaker or removing the fuses before you perform any maintenance; otherwise it may cause electrical shock resulting in severe injury or death.**

Before you perform any maintenance, turn off the power by opening the circuit breaker as below

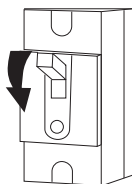

Clean and check the product regularly to maintain optimal performance and to prevent possible break down. If you have difficulty to perform these routine maintenance tasks yourself, contact a qualified person.

## **Draining and Flushing the Water Heater**

Minerals contained in tap water can form lime deposits. Therefore, it is not uncommon that lime deposits accumulate in the water heater's tank. The amount of lime deposits depends on water hardness, the temperature settings, and other variables.

- 1** Turn off the power by opening the circuit breaker or removing the fuses.
- 2** Connect a garden hose to the drain valve and place the end of the hose in a suitable drain.
- 3** Turn off the cold water supply valve.
- 4** Open the drain valve. (Open a hot water faucet or lift the handle on the T&P relief valve to help the water drain faster.)
- 5** Once the tank is empty, flush the tank by opening the cold water supply valve.
- 6** Allow the water run until no more sediment drains from the tank and water runs clear.
- 7** Close the drain valve and open the hot water faucet. Fill the tank by opening the cold water valve.

## T&P Relief Valve Maintenance

### **⚠ DANGER**

Before manually operating the relief valve, make sure it will discharge in a safe place. If water does not flow freely from the end of the discharge pipe, turn off the power to water heater and call a qualified person.

At least annually, lift and release the lever handle on water heater to ensure the waterways are clear and the valve operates freely.

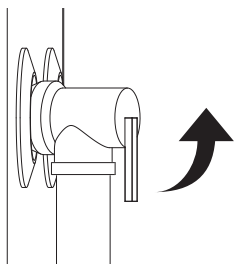

## Air Filter Maintenance

Clean the air filters when "Air filter check (  )" alarm appears on the display.

### NOTE

- The air filter can be broken when it is bended.
- When the air filter is not assembled correctly, dust and other substance come into the unit.

- 1 Turn off the power by opening the circuit breaker or removing the fuses.
- 2 Hold the knobs of the air filter, pull it and remove it from the top cover.

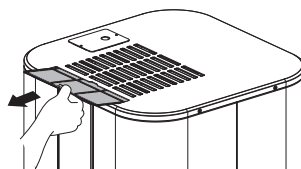

- 3 Clean the filter with a vacuum cleaner or with lukewarm water with neutral detergent.
- 4 Dry the filter in the shade.
- 5 Insert the air filter into the top cover.

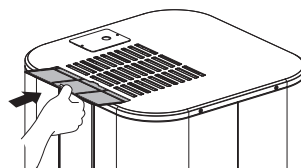

- 6 Check the top cover for correct assembly of the air filter.

## Condensate Drain Maintenance

- 1 Remove the condensate drain lines and connections.

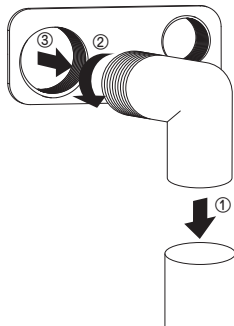

- 2 Pull the front decor first, and then remove the top cover. Lift the front panel out, then slightly lift the rear panel and remove it.

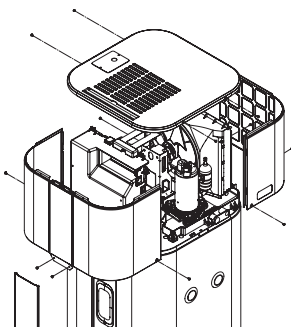

- 3 Check the condensate drain pan for any debris, and clean the condensate drain by wiping out with a damp cloth or pouring a cup of bleach.
- 4 Reattach top cover and side panel and connect the condensate drain line.
- 5 Restore power to the water heater.

## Shut-down for an Extended Period

If the water heater will not be used for an extended period of time, turn off the power and water supply to water heater and drain water heater to conserve energy and prevent a build-up of dangerous hydrogen gas.

The water heater and piping should be drained if they might be subjected to freezing temperature.

After a long shutdown period, the water heater's operation and controls should be checked by qualified service personnel. Make certain the water heater is completely filled again before placing it in operation.

# TROUBLESHOOTING

EN

## Before Calling for Service

Please check the following before you contact the service center. If the problem persists, contact your local service center.

### CAUTION

For your safety, do not attempt to repair of electrical wiring, controls, heating elements or other safety devices. Refer repairs to qualified service personnel.

Problem	Possible Causes & Corrective Action
Insufficient or no hot water	<b>Water usage exceeds the capacity of the water heater in current mode</b> <ul style="list-style-type: none"> <li>• Wait for the water heater to recover after an abnormal demand.</li> <li>• Change the mode for higher recovery.</li> </ul>
	<b>Water temperature set too low</b> <ul style="list-style-type: none"> <li>• See the "Water Temperature Adjustment" section.(Page 24)</li> </ul>
	<b>ECO tripped</b> <ul style="list-style-type: none"> <li>• See "Safety Controls" section.(Page 21)</li> </ul>
	<b>No electric supply to the water heater</b> <ul style="list-style-type: none"> <li>• Check the electric supply to water heater. See "Making Electrical Connections" section.(Page 20)</li> </ul>
	<b>Water connections to unit are reversed</b> <ul style="list-style-type: none"> <li>• Re-install water connection correctly</li> </ul>
	<b>Leak in hot water faucets or plumbing system</b> <ul style="list-style-type: none"> <li>• Make certain all faucets are closed.</li> <li>• Check home for any leaks and repair</li> </ul>
	<b>Improper electric wiring</b> <ul style="list-style-type: none"> <li>• See "Making Electrical Connections" section.(Page 20)</li> </ul>
	<b>Cold water inlet temperature may be lower in winter</b> <ul style="list-style-type: none"> <li>• This is normal. The colder inlet water takes longer to heat.</li> </ul>
	<b>Dirty air filter</b> <ul style="list-style-type: none"> <li>• See "Air Filter Maintenance" section.(Page 28)</li> </ul>
	<b>Not enough clearance to air exchange for heat pump</b> <ul style="list-style-type: none"> <li>• Make sure unit has enough clearance. See "Select the best Location" section.(Page 15)</li> </ul>
Water is too hot	<b>Open fuse or a circuit breaker tripped</b> <ul style="list-style-type: none"> <li>• Replace fuse or reset circuit breaker.</li> </ul>
	<b>Water temperature set too high</b> <ul style="list-style-type: none"> <li>• See the "Water Temperature Adjustment" section.(Page 24)</li> </ul>

Problem	Possible Causes & Corrective Action
Noise	<p><b>The heat pump compressor, fan, or EEV valve is running</b></p> <ul style="list-style-type: none"> <li>• This is normal</li> </ul>
	<p><b>Build up of scale or lime deposits on heating elements may cause rumbling noise</b></p> <ul style="list-style-type: none"> <li>• Clean or replace the heating elements. This should only be performed by qualified service person. Call our Technical Support Center.</li> </ul>
Drips from the outside of the heater	<p><b>Condensate drain is blocked</b></p> <ul style="list-style-type: none"> <li>• Clean the drain port and remove the debris.</li> </ul>
	<p><b>Hot/Cold water connections or other parts have loosened</b></p> <ul style="list-style-type: none"> <li>• Tighten the loose connections. This should only be done by a qualified service person.</li> </ul>
Noise and drips from relief valve	<p><b>Pressure build-up due to thermal expansion in a closed water system.</b></p> <ul style="list-style-type: none"> <li>• This is an unacceptable condition and must be corrected. Do not plug the T&amp;P relief valve outlet. Contact a plumbing contractor to correct this.</li> </ul>
Water pressure is low	<p><b>Supply valve is partially closed</b></p> <ul style="list-style-type: none"> <li>• Open the water heater's supply valve fully.</li> </ul>
Trouble connecting appliance and smartphone to Wi-Fi network.	<p><b>The password for the Wi-Fi network was entered incorrectly.</b></p> <ul style="list-style-type: none"> <li>• Delete your home Wi-Fi network and begin the registration process again.</li> </ul>
	<p><b>Mobile data for your smartphone is turned on.</b></p> <ul style="list-style-type: none"> <li>• Turn off the <b>Mobile data</b> on your smartphone before registering the appliance.</li> </ul>
	<p><b>The wireless network name (SSID) is set incorrectly.</b></p> <ul style="list-style-type: none"> <li>• The wireless network name (SSID) should be a combination of English letters and numbers. (Do not use special characters.)</li> </ul>
	<p><b>The router frequency is not 2.4 GHz.</b></p> <ul style="list-style-type: none"> <li>• Only a 2.4 GHz router frequency is supported. Set the wireless router to 2.4 GHz and connect the appliance to the wireless router. To check the router frequency, check with your Internet service provider or the router manufacturer.</li> </ul>
	<p><b>The distance between the appliance and the router are too far.</b></p> <ul style="list-style-type: none"> <li>• If the appliance is too far from the router, the signal may be weak and the connection may not be router closer to the appliance or purchase and install a Wi-Fi repeater.</li> </ul>

## Error Code

Code	Contents	Corrective Action	Operating status
1	Ambient Temp sensor is not working.	Call our Technical Support Center.	Use Elements Only
4	Condensate drain is blocked.	Clean Condensate drain. See "Condensate Drain Maintenance" section.	Use Elements Only
5	PCB Communication error.	Call our Technical Support Center.	Use Elements Only
6	Lower tank Temp sensor is not working.	Call our Technical Support Center.	OFF
9	EEPROM error.	Call our Technical Support Center.	Use Elements Only
12	Mid pipe Temp sensor is not working.		
19	Upper element is not working.	Call our Technical Support Center.	Use Heat Pump Only
20	Lower element is not working.		
21	DC Peak (IPM Fault).	Call our Technical Support Center.	Use Elements Only
22	CT 2 (Max, Current).		
23	DC Link Low/High Volt.		
26	DC Comp Position Error, LOCKIG.		
27	PSC Fault.		
29	Comp Phase is Over-Current.		
32	Discharge pipe is overheated.(105 °C)	Call our Technical Support Center.	Use Elements Only
41	Discharge pipe Temp sensor is not working.		
46	Suction Pipe Temp sensor is not working.		
61	Cond. Pipe Temp is High.(65 °C)		
65	Heat sink Temp sensor is not working.		
67	BLDC motor fan is locked.		
DF	No or not enough water in tank.	Fill water heater with water. Open all hot water faucets until water flows with a full stream.	OFF
EC	ECO is tripped.	Disconnect all power to water heater. See "Safety Controls" section. Call our Technical Support Center.	OFF
H1	Water Temp is too High.	Call our Technical Support Center.	OFF
H2			
L1	Water Temp is too Low.	Call our Technical Support Center.	OFF
L2	Water Temp is too low or upper tank Temp sensor is not working.		
IC	ICCP is not functioning	Call our Technical Support Center.	OFF



## Replacement Parts List

Item No.	Description
1	Panel Assembly,Front
2	PCB Assembly,Display
3	Front decor (Cover,Terminal)
4	Cover Assembly,Top
5	Filter Assembly,Air Cleaner
6	Cover Assembly,Control
7	PCB Assembly,Power
8	PCB Assembly,Main
9	PCB Assembly,Module
10	Transformer,Reactor
11	Case Assembly,Control
12	Panel,Rear
13	Bracket,Motor
14	Motor Assembly,DC,Outdoor
15	Fan,Propeller
16	Nut,Common
17	Shroud Assembly
18	Evaporator Assembly,First

Item No.	Description
19	Switch Assembly
20	Pan Assembly,Drain
21	Compressor Set,China
22	Damper,Compressor
23	Tube Assembly,Reverse
24	Coil,Expansion
25	Tube Assembly,Expansion
26	Tube Assembly,Evaporator(Out)
27	Tube Assembly,Connector
28	Tube Assembly,Evaporator(In)
29	Harness,Multi
30	Harness,Multi
31	Thermistor Assembly,NTC
32	Thermistor Assembly,NTC
33	Thermistor Assembly,NTC
34	Bracket
*	Refrigerant

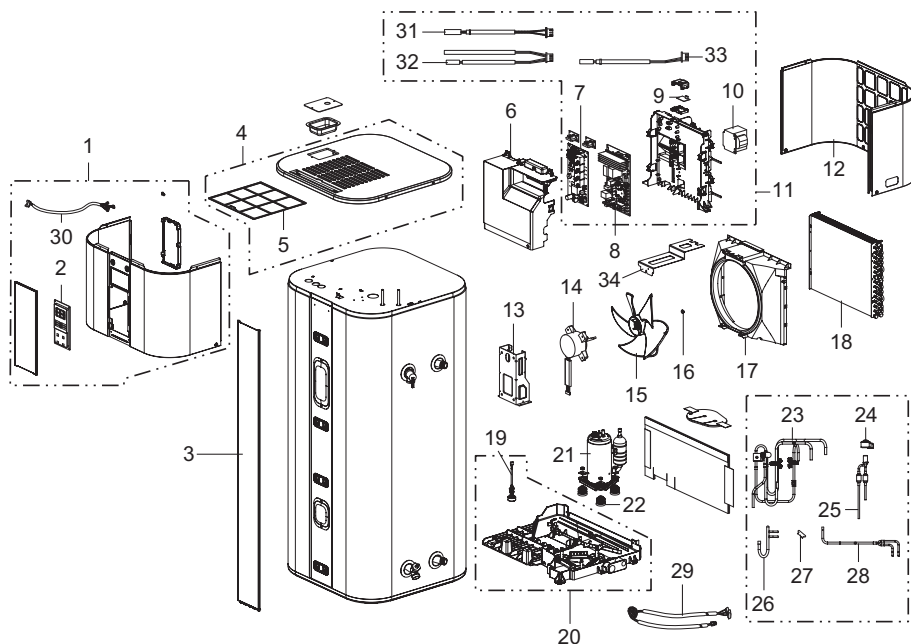

 **CAUTION**

**For your safety, Do not attempt to repair electronic controls, electrical wiring, heat pump, heating elements or other safety devices by yourself. Refer repair to authorized service center.**

**NOTE**

- Check the water heater's rating plate on the unit for the acceptable voltage and wattage.

Replacement parts can be ordered through the distributor or store where the heater was purchased.

All parts order should include following information:

1. Model and serial number of the products.
2. Voltage and wattage as marked on rating plate.
3. Part description.

## Technical specification

Description	Unit	WH20S F5	WH27S F5
Tank Capacity	L	200	270
Dimension (Width x Height x Depth)	mm	580 x 1625 x 582	580 x 2008 x 582
Weight empty	kg	100	119
Diameter of water connections	-	G 3/4"	
Diameter of condensate drainage connections	-	3/4" 1/2"	
Type of corrosion protection	-	Impressed Current Cathodic protection	
Type of internal tank protection	-	Ceramic coated	
Max Working pressure	MPa	1	
Setting range of the water temperature	°C	35 to 60	
Operating temperature range of the heat pump	°C	-5 to 50	
Refrigerant R134a	kg	0.65	0.75
Refrigerant volume in equivalent tonnes	T.eq.CO <sub>2</sub>	0.930	1.072
Refrigerant design pressure (high side / low side)	MPa	2.0 / 0.9	
<b>Power supply</b>			
Voltage	V	230	
Frequency	Hz	50	
Total Max power consumption	W	2600	
Max power consumption by heat pump	W	550	
Max power consumption by heating element	W	2050	
Protection rating		IPX1	
<b>Air side</b>			
Air flow rate (H/M)	m <sup>3</sup> /min	6.7/4.4	6.7/4.4
Available static pressure	Pa	90	90

EN